

PRODUCT DATASHEET

QTi DALI 4X18 DIM

QUICKTRONIC INTELLIGENT DALI DIM T8 | ECG dimmable DALI for FL 26 mm



AREAS OF APPLICATION

- Suitable for use in emergency lighting systems as per EN 50172/DIN VDE 0108-100
- Installation in emergency lighting systems according to IEC 61347-2-3, appendix J
- Industry
- Open-plan offices, corridors and storage rooms
- Public buildings
- Sports halls and factories
- Strip lighting
- Suitable for luminaires of protection class I

PRODUCT BENEFITS

- System+ Guarantee available
- Easy integration in luminaire thanks to same dimensions like DALI GI ECG
- TouchDIM function for easy and inexpensive dimming of several ECGs
- Same luminous flux with direct and alternating current
- Dimming of amalgam lamps without flickering or reduced lifespan
- Automatic restart after lamp replacement
- No new approvals required

DALI PRODUCT FEATURES

- Control via the DALI interface
- Compliance with the DALI Version-1 and IEC 60929
- Control input protected against overvoltage and polarity reversal (OSRAM ECG)

TOUCH DIM AND TOUCH DIM SENSOR FUNCTION

- Manual dimming without controller and with standard switches
- Including memory function (double click) and soft start

PRODUCT FEATURES

- Corridor function for direct connection of ECG to common motion sensor
- Corridor function with pre-programmed light program
- Touch DIM function for free parameterization of light value and turn on time
- Fit for SMART GRID for feedback of consumed mains power and lamp operating hours
- Fit for Emergency function for automatic detection of emergency lighting by ECG
- Very low standby power consumption: < 0.2 W (A1 BAT)
- Lifetime: > 100,000 h (for T = 65 °C at T_c)
- Very high number of switching cycles: up to 300,000
- Dimming range: 1...100 % (3...100 % with compact fluorescent lamp)
- POWER2LAMP function for optimal matching of ECG power to lamp during lamp lifetime
- Line frequency: 0 Hz, 50...60 Hz, rectified AC

TECHNICAL DATA

Electrical data

Input voltage AC	198...264 V
Nominal voltage	220...240 V
Mains frequency	50...60 Hz
Input voltage DC	154...276 V
Operating frequency	40...100 kHz
Max. ECG no. on circuit breaker 10 A (B)	12 ¹⁾
Max. ECG no. on circuit breaker 16 A (B)	19 ¹⁾
Power loss in stand-by mode	<0.5 W
Inrush current	35 A

¹⁾ Type B

Light technical data

Starting time	1.2 s
----------------------	-------

Dimensions & weight

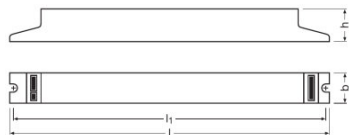

Length	360.0 mm
Width	40.0 mm
Height	21.0 mm
Mounting hole spacing, length	350.0 mm
Product weight	374.00 g
Wire preparation length, input side	8.0...9.0 mm ¹⁾
Wire preparation length, output side	8.0...9.0 mm ¹⁾
Cable cross-section, output side	0.5...1.5 / 0.5...1.0 mm ² ²⁾
Cable cross-section, input side	0.5...1.5 / 0.5...1.0 mm ² ²⁾

¹⁾ Combi wiring

²⁾ Solid leads / Flexible

Temperatures & operating conditions

Ambient temperature range	0...+50 °C
Permitted rel. humidity during operation	5...85 %

Lifespan

ECG lifetime	100000 h ¹⁾
---------------------	------------------------

¹⁾ At $T_{case} = 65^{\circ}C$ at T_c point / 10% failure rate

Expected Lifetime

Product name	Lamp group				
QTi DALI 4X18 DIM	L 18 W	ECG ambient temperature [ta]	40	50	60
		Temperature at tc-point [°C]	55	65	75
		Lifetime [h]	100000	100000	90000

Capabilities

Dimming interface	DALI / Touch DIM / Touch DIM Sensor
Dimming range	1...100 % ¹⁾
Dimmable	Yes
Overload protection	Yes
Overheating protection	Power reduction and switch off at T > 75 °C at the tc point
Suitable for fixtures with prot. class	I
End of lamp life safety shutdown	EOL T.2

¹⁾ Luminous flux

Certificates & standards

Approval marks – approval	VDE / VDE-EMC / ENEC 10 / EL / GOST / RCM / CCC
Standards	Acc. to EN 61347-2-3/Acc. to EN 60929/Acc. to EN 55015:2006 + A1:2007/Acc. to EN 61000-3-2/Acc. to EN 61547/Acc. to IEC 62386-101:Ed1/Acc. to IEC 62386-102:Ed1
EEL – Energy Label	A1 BAT
Protection class	I
Type of protection	IP20

Wiring Diagram

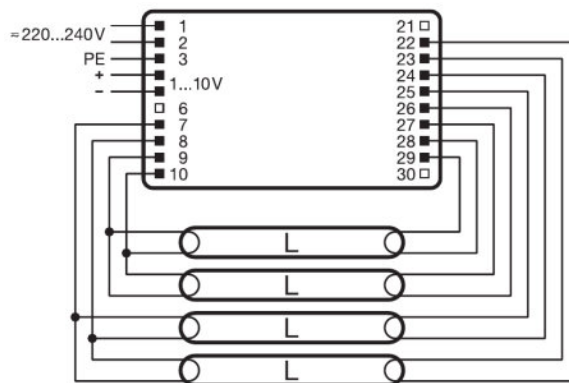
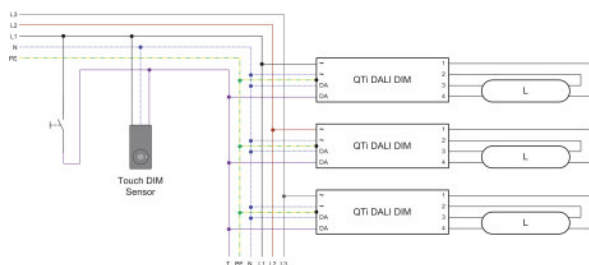

Wiring diagram

Wiring diagram

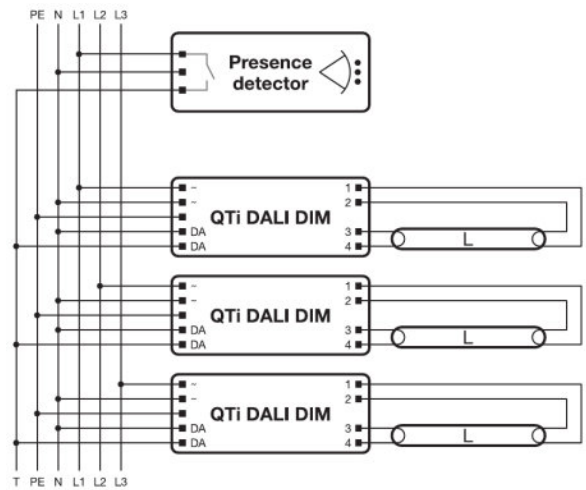



Wiring diagram

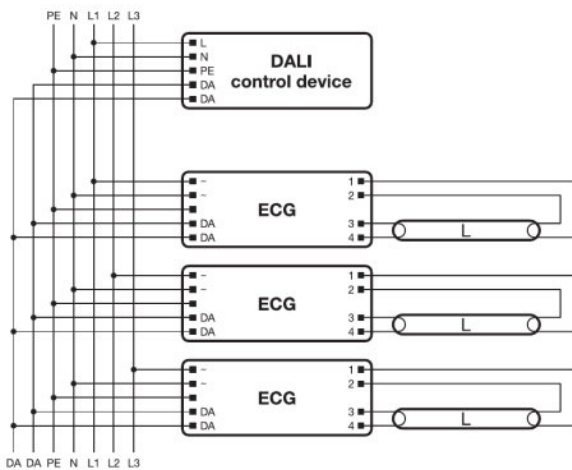















Wiring diagram



Wiring diagram

DOWNLOAD DATA

File	
	Addon Technical Information 502689_Frequent switching Quicktronic
	Addon Technical Information 502785_ECG lifetime - QUICKTRONIC (DALI) DIM

	Brochures 333874_Bochure – DALI partner
	Certificates 554891_EAC PT family
	Certificates 335097_INOTEC
	Certificates 335125_ENECVDE-Marks approval
	Certificates 335135_Manufacturer's declaration – Burning-in of fluorescent lamps
	Certificates 335153_Manufacturer's declaration – Low stand-by
	Certificates 335154_Manufacturer's declaration – EN 55015:2006+A1:2007 (300 MHz)
	Certificates 335169_Manufacturer's declaration – LampECG combinations: Frequent switching
	Certificates 335190_Manufacturer's declaration –Additional hints
	Certificates 504208_VDE-EMC-CERTIFICATE QTi DALI DIM
	Declarations of conformity 334957_Declaration of conformity
	Installation/Operation notice 493509_Technical application guide QUICKTRONIC Intelligent DALI DIM (GB)
	Operating instructions 592413_EAC QTi T8 DALI DIM
	CAD data 3-dim 313451_360x40x21 9900042
	CAD data 3-dim 313478_360x40x21 9900042
	CAD data 3-dim 314276_360x40x21 9900042
	CAD data PDF 313387_360x40x21 9900042

LOGISTICAL DATA

Product code	Product description	Packaging unit (Pieces/Unit)	Dimensions (length x width x height)	Volume	Gross weight
4008321070050	QTi DALI 4X18 DIM	Shipping carton box 20	380 mm x 96 mm x 206 mm	7.51 dm ³	7752.50 g

The mentioned product code describes the smallest quantity unit which can be ordered. One shipping unit can contain one or more single products. When placing an order, for the quantity please enter single or multiples of a shipping unit.

REFERENCES / LINKS

For more information on the system guarantee and the terms and conditions of the guarantee visit

▶ www.ledvance.com/system-guarantee

DISCLAIMER

Subject to change without notice. Errors and omission excepted. Always make sure to use the most recent release.

QUICKTRONIC INTELLIGENT DALI DIM T8 | ECG dimmable DALI for FL 26 mm

Product name	Lamp group	Nominal current	Nominal wattage + Power loss	Luminous flux at 35 °C	Number of lighting outlets
QTi DALI 4X18 DIM	DULUX F 18 W	0.31 A	69.30 W	1100 lm	4
	DULUX L 18 W	0.31 A	69.30 W	1200 lm	4
	L 18 W	0.31 A	69.30 W	1350 lm	4
	L 18 W XT	0.31 A	69.30 W	1350 lm	4
	L 18 W XXT	0.31 A	69.30 W	1350 lm	4