

Wide range of switches, energy sockets (compliant with national and international standards), data sockets, devices for the management of climate control, comfort, technical alarms signalling, emergency lighting. The Chorus modular devices are available in four colors, glossy white, satin black, painted titanium and glossy ivory and in different modularities, 1/2, 1, 2 and 3 modules. Thanks to the frame supports for rectangular, square and round boxes, the devices allow you to create endless combinations with the range of Chorus plates.

Category	Push-button	Button key	With replaceable neutral lens
Colour	Ivory	Description	1P NO - 16A illuminable
Voltage	250 V ac	Standard	EN 60669-1
Resistance at test voltage	2000 V at 50 Hz for 1 minute	Insulation resistance	> 5 MOhm
Wiring terminals	With screw	Prolonged operation switch (no.of position changes)	40.000 at In 250 V ac cosØ=0,6
Thermo-pressure with ball	125 °C	Glow Wire Test	850 °C
Terminal grip on cable traction	> 50 N	Terminal tightening capacity stranded cables (mm2)	min. 0,75 - max. 2x4
Terminal tightening capacity solid cables (mm2)	min. 0,5 - max. 2x2,5	No. Chorus modules	1

DIMENSIONAL

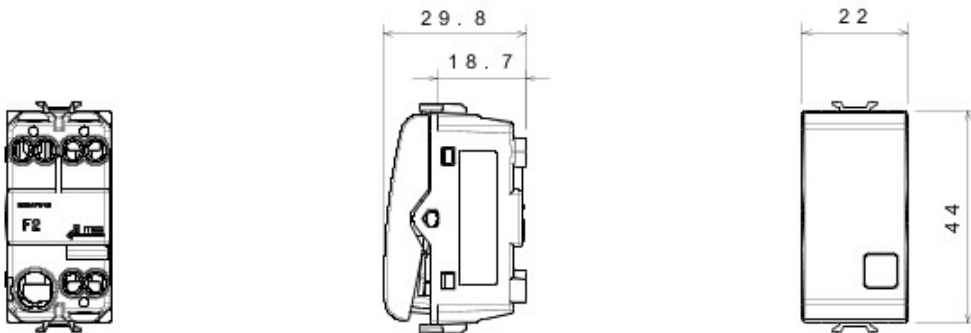

TECHNICAL SYMBOLOGY



STANDARDS/APPROVALS



GEWISS S.p.A. Via A. Volta, 1
24069 Cenate Sotto - Bergamo - Italy
tel. +39 035 94 61 11 fax +39 035 94 69 09

www.gewiss.com
sat@gewiss.com
Last update 22/04/2020

Data, measures, designs and pictures are for information purpose only, last update. They can be changed at any moment, therefore it is always recommended to read the last updated version published on the website www.gewiss.com. Lumen

output and system power are subject to a tolerance of +/- 10%. Unless stated otherwise, the values apply to an ambient temperature of 25°C. Terms of warranty at <https://www.gewiss.com/it/en/company/landingpage/led-warranty>.