

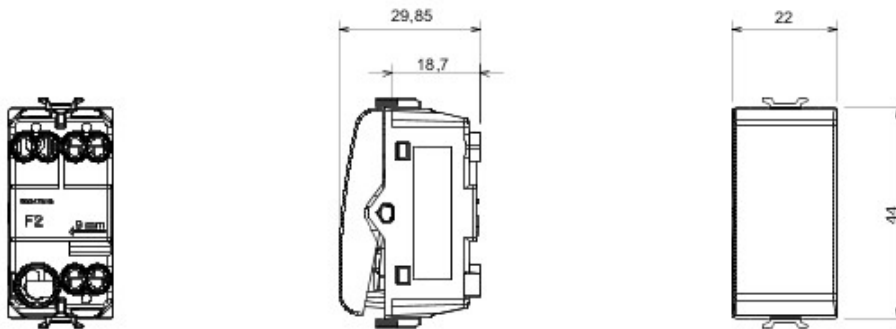

Wide range of switches, energy sockets (compliant with national and international standards), data sockets, devices for the management of climate control, comfort, technical alarms signalling, emergency lighting. The Chorus modular devices are available in four colors, glossy white, satin black, painted titanium and glossy ivory and in different modularities, 1/2, 1, 2 and 3 modules. Thanks to the frame supports for rectangular, square and round boxes, the devices allow you to create endless combinations with the range of Chorus plates.

Category	One-way switch	Button key	Neutral
Colour	Ivory	Description	1P - 16AX
Voltage	250 V ac	Standard	EN 60669-1
Resistance at test voltage	2000 V at 50 Hz for 1 minute	Rated power of 230V LED lamps	200 W
Insulation resistance	> 5 MOhm	Wiring terminals	With screw
Prolonged operation switch (no.of position changes)	40.000 at In 250 V ac cosØ=0,6	Thermo-pressure with ball	125 °C
Glow Wire Test	850 °C	Terminal grip on cable traction	> 50 N
Terminal tightening capacity stranded cables (mm2)	min. 0,75 - max. 2x4	Terminal tightening capacity solid cables (mm2)	min. 0,5 - max. 2x2,5
No. Chorus modules	1		

### DIMENSIONAL



### TECHNICAL SYMBOLOGY



### STANDARDS/APPROVALS



GEWISS S.p.A. Via A. Volta, 1  
24069 Cenate Sotto - Bergamo - Italy  
tel. +39 035 94 61 11 fax +39 035 94 69 09

www.gewiss.com  
sat@gewiss.com  
Last update 21/04/2020

Data, measures, designs and pictures are for information purpose only, last update. They can be changed at any moment, therefore it is always recommended to read the last updated version published on the website www.gewiss.com. Lumen

output and system power are subject to a tolerance of +/- 10%. Unless stated otherwise, the values apply to an ambient temperature of 25°C. Terms of warranty at <https://www.gewiss.com/it/en/company/landingpage/led-warranty>.