

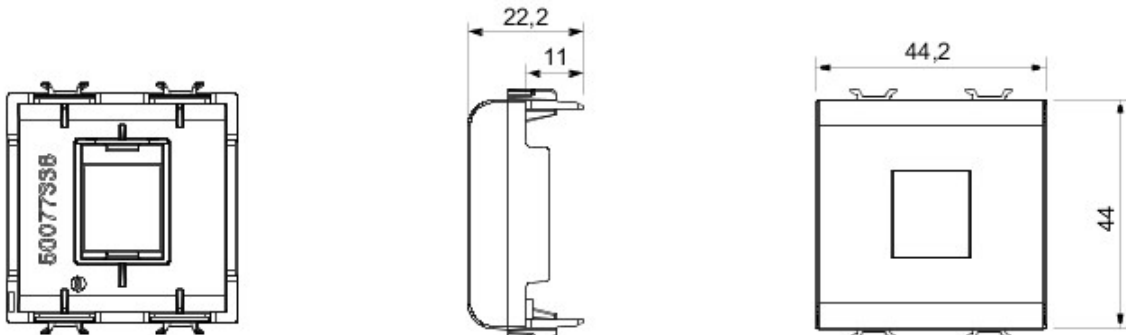

Wide range of switches, energy sockets (compliant with national and international standards), data sockets, devices for the management of climate control, comfort, technical alarms signalling, emergency lighting. The Chorus modular devices are available in four colors, glossy white, satin black, painted titanium and glossy ivory and in different modularities, 1/2, 1, 2 and 3 modules. Thanks to the frame supports for rectangular, square and round boxes, the devices allow you to create endless combinations with the range of Chorus plates.

Category	Adapter	Colour	White
Compatibility	AMP / Keystone Jack	No. Chorus modules	2
Electrocod	0131		

DIMENSIONAL



GEWISS S.p.A. Via A. Volta, 1
24069 Cenate Sotto - Bergamo - Italy
tel. +39 035 94 61 11 fax +39 035 94 69 09

www.gewiss.com
sat@gewiss.com
Last update 12/05/2020

Data, measures, designs and pictures are for information purpose only, last update . They can be changed at any moment, therefore it is always recommended to read the last updated version published on the website www.gewiss.com. Lumen output and system power are subject to a tolerance of +/- 10%. Unless stated otherwise, the values apply to an ambient temperature of 25°C. Terms of warranty at <https://www.gewiss.com/it/en/company/landingpage/led-warranty>.