

The Chorus modular range allows you to create a wide variety of functions, thanks to the modular structure of the numerous products offered.

In addition to the traditional electromechanical devices (commands, socket-outlets, protection etc.), there are also electronic devices for the command and control of services, such as regulators, timers and dimmers. Furthermore, a wide selection of products has been developed for special services and wireless systems.

The Chorus range for domestic use has a modular structure on flush-mounting frames up to 12 modules. Surface-mounting and free-standing boxes and plates are included, along with watertight plates (IP55) and outdoor containers (IP40 and IP55).

TECHNICAL DATA AND REFERENCE STANDARDS							
Component	Reference standards	Essential electrical data*			Prolonged operation (no. of position changes)	Resistance to abnormal heat and fire	
		Resistance at test voltage (V)	Insulation resistance (MΩ)	Breaking capacity or category of use		Thermo-pressure with ball (°C)	Glow Wire Test (°C)
Commands	EN 60669-1	2000 at 50 Hz for 1 minute	> 5	1.25 I _n (200 position changes)	40,000 at I _n 250V- cosφ = 0.6	125	850
Italian Std. socket-outlets	IEC 60884-1			1.25 I _n (100 position changes)	10,000 at I _n 250V- cosφ = 0.8		
International Std. socket-outlets	IEC 60884-1			1.25 I _n (100 position changes)	10,000 at I _n 250V- cosφ = 0.8		
Latching relays	EN 60669-1 / EN 60669-2-2				40,000 at I _n 250V- cosφ = 0.6		
Momentary relays	EN 60669-1 / EN 60669-2-2			1.25 I _n (200 position changes)			
Miniature circuit breakers	EN 60898-1		2** ± 5	3KA	8,000		
Residual current circuit breakers	EN 61009-1 / EN 61008-1			3KA	4,000		
Supports and plates	EN 60669-1	-	-	-	-	70	650

* For rated voltages and currents, see the specifications for the individual codes. ** The value of 2 MΩ refers to a special condition established by the Standards given alongside.

Characteristics of screw terminals

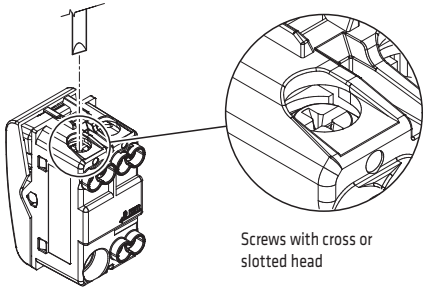

The terminals, located in the rear part of the devices, are manoeuvrable even after coupling the component to the support, and are suitable for both stranded and solid cables. The components are supplied with the screws of the terminals open, to reduce wiring times.

TECHNICAL DATA			
Terminal grip on cable traction		>50N	
TERMINAL TIGHTENING CAPACITY			
Stranded wires		Solid wires	
Minimum 0.75mm ²	Maximum 2 x 4mm ²	Minimum 0.5mm ²	Maximum 2 x 2.5mm ²

Characteristics of spring terminals

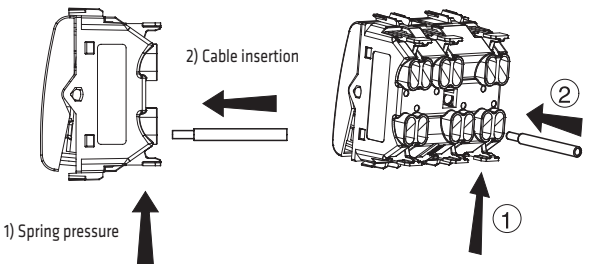

The spring terminals allow you to carry out the wiring in a shorter time, and without using screwdrivers or other tools. To insert the cable, it is necessary to press the orange lever (opening of terminal). Releasing the lever, the terminal closes automatically, firmly blocking the cable.

TECHNICAL DATA			
Terminal grip on cable traction		>50N	
TERMINAL TIGHTENING CAPACITY			
Stranded wires		Solid wires	
Minimum 0.75mm ²	Maximum 2 x 4mm ²	Minimum 0.5mm ²	Maximum 2 x 2.5mm ²

Characteristics of signalling and night-time localisation devices

Type of coupling	Illuminated devices	Substitution of the button key	Substitution of the signalling lens for functional signalling	Interchangeability of the 22x22mm button keys
<p>The front coupling of the Chorus devices makes the support assembly and release operations quick and easy, without the necessity to remove the support.</p>	<p>Seat for insertion of miniature lamps with wired lead</p>			<p>Replacing a button key</p> <p>Substitution of diffuser and personalised label</p>

Backlighting of command devices

Type	Use	Applications	Type	Use	Applications
<p>Lighting for localisation purposes</p>	Permits the identification of the command button in the dark, or the indication of the ON/OFF status of a lighting circuit	<ul style="list-style-type: none"> General services of a building complex (stair lights, entrances, etc.) Public entertainment premises Bedrooms Corridors 	<p>Diffuser 22x22mm</p>	Permits the identification of the ON/OFF status of a service or lighting circuit from a distance. The signalling is clearly visible from the front	Signalling of lights coming on outside the place where the command device is installed
<p>Lighting for signalling</p>	Permits the identification of the command button, and its specific function, in the dark	<ul style="list-style-type: none"> General services Indoor systems for offices, shops, warehouses. Hotel facilities Hospitals and nursing homes 	<p>Push-buttons with illuminated name plate</p>	Permits the identification of the command button in the dark, and the reading of the name on the label, even in poorly lit areas	Push-button for call circuits in homes and offices

Examples of function and location lighting

To indicate the operating status of services not visible from the command position

The indicator lamp is located parallel to the service, and is switched on when the one-way switch is ON. The indicator lamp follows the ON/OFF status of the service.

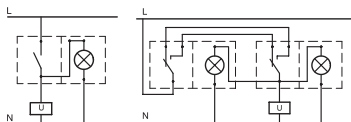

The two indicator lamps and the service are placed in parallel, therefore they switch on and off together with the service

To locate the command key in the dark

The indicator lamp is switched on when the one-way switch is OFF. With the one-way switch in the ON position, the service is powered and the indicator lamp is switched off.

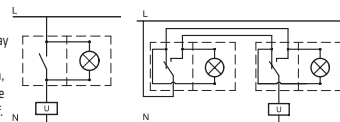

The two indicator lamps come on when the service is not powered and go off when it is ON.

NOTE: layouts not suitable for commanding compact energy saving lamps, LED lamps and/or relays

Degree of protection of the set of CHORUS domestic range devices installed

Component	Installation	Reference standard	IP rating
Devices with closed front (commands, bells, indicators, etc.) installed in flush-mounting boxes, surface-mounting boxes, free-standing panels (completed with support and plate) and in self-supporting boxes	Flush-mounting for domestic or similar finish, in vertical position, installed to a high standard	EN60529 (CEI 70-1)	41
Devices with open front (socket-outlets, etc.) installed in flush-mounting boxes, surface-mounting boxes, free-standing panels (completed with support and plate) and in self-supporting boxes	Flush-mounting for domestic or similar finish, in vertical position, installed to a high standard. Suitable for use for zone 3 of rooms containing baths or showers.		X 1 (in case of socket-outlets it is 21)
Devices with open front (socket-outlets, etc.) installed in flush-mounting boxes, surface-mounting boxes, free-standing panels (completed with support and plate) and in self-supporting boxes	Flush-mounting for domestic or similar finish, in vertical position, installed to a high standard with plug inserted		4 X

COMMAND

Infrared movement detectors

The passive infrared movement detector senses temperature variations within its range of action and, depending on the environmental light, closes a relay contact. When movement stops, the contact automatically opens again after an adjustable set time. The device incorporates a light-sensitive sensor with an adjustable trip threshold to avoid controlling the circuit (e.g. lighting equipment) when not necessary.

Fixed lens

Reference standards: EN 60669-1, EN 60669-2-1

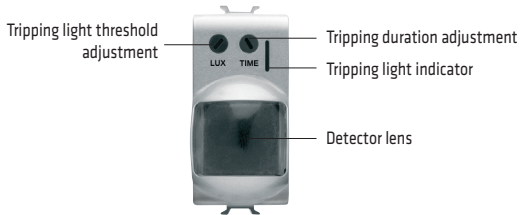

GW 10 591 - GW 12 591 - GW 14 591

NOTE: Not suitable for compensated fluorescent lamps, for discharge lamps and for those loads not indicated; please use an auxiliary relay to control such lamps.

The exclusion of the light-sensitive threshold is obtained by positioning the luminosity selector at the maximum.

TECHNICAL DATA	
Power supply voltage	230V AC - 50/60 Hz
Light-sensitive threshold setting	10 lux - max. inhibited
Activation duration setting	15 sec / 10 min
Output contact	1 NO 3A (AC1) 250V ac, potential-free
Type of load:	
Resistive loads	700W
Incandescent lamps	450W
Low voltage halogen lamps (12V)	450W
Uncompensated fluorescent lamps	2x58W
Motors and motor reduction units	400VA
Operating temperature	-5 to +40°C
Relative humidity	max. 93% non condensative

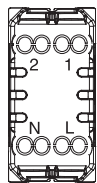

Wiring terminals

Power supply:
L - Phase
N - Neutral

Potential-free output:
1 / 2 - NO contact

Connection diagram

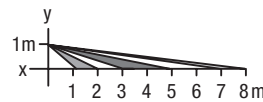
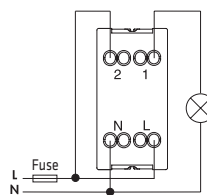

Coverage diagram

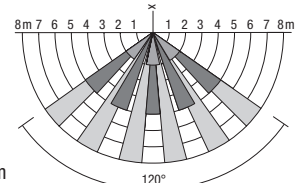

Directional lens

Reference standards: EN 60669-1, EN 60669-2-1

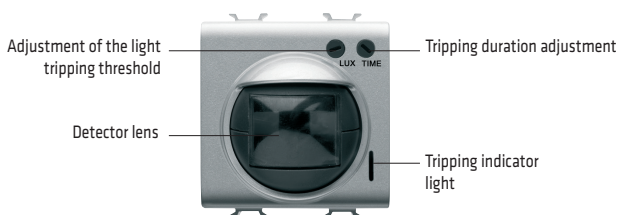

GW 10 592 - GW 12 592 - GW 14 592

Not suitable for compensated fluorescent lamps; please use an auxiliary relay to control such lamps.

It is possible to connect the input of the device with several NO push-buttons, connected side by side. This solution is suitable, for example, for the installation of the device in an environment where the light-sensitive module is positioned in the entrance, for the automatic switching-on of the lights in dark conditions, while in the other points push-buttons are used to switch the lights on manually. The activation is always subject to the light-sensitive module and the adjusted timer, via the potentiometer. The exclusion of the light-sensitive threshold is obtained by positioning the luminosity selector at the maximum.

TECHNICAL DATA	
Power supply voltage	230V AC - 50/60 Hz
Light-sensitive threshold setting	10 lux - max. inhibited
Activation duration setting	15 sec / 10 min
Output contact	1 NO 16A (AC1) / 10A (AC15) 250V AC potential-free
Uncompensated fluorescent lamp command	max. 4A
Operating temperature	-5 to +40°C
Relative humidity	max. 93% non condensative

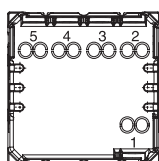

Wiring terminals

Power supply:
2 - Phase
3 - Neutral

Potential-free output:
4 / 5 - NO contact

Input:
1 - Remote command

Connection diagram

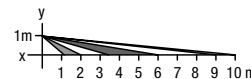
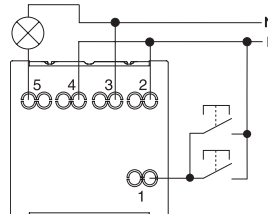

Coverage diagram

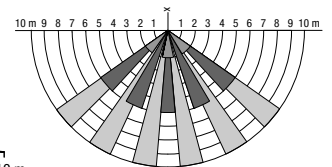

For technical information contact the Technical Assistance Service or visit gewiss.com

Infrared receiver and remote control

The infrared system is made up of a portable remote control with 6 channels/3 bands, and a single-channel receiver with relay output for the ON-OFF command of a specific service (light point, fan, etc.).

The remote control is able to manage up to 18 receivers.

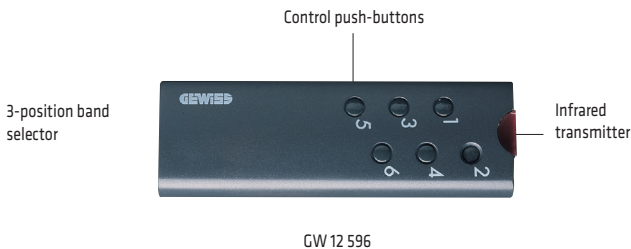

TECHNICAL DATA	
No. of channels	6
No. of push-buttons	6
Band selector	3 positions - housed in the battery compartment The setting of the internal microswitch on 3 bands prevents interference with other remote controls.
Max capacity	10m
Power supply	2 alkaline-type batteries (1.5V AAA)

1-channel receiver

Suitable for use in open spaces, where there are no obstacles between the receiver and the remote control, and the maximum distance between the two devices is 10m. Equipped with an 18-position rear selector for determining the appropriate remote control channel. For different and more specialised applications, it is possible to use the corresponding articles of the wireless range.

Reference standards: EN 60669-1; 60669-2-1; EN 60669-2-2

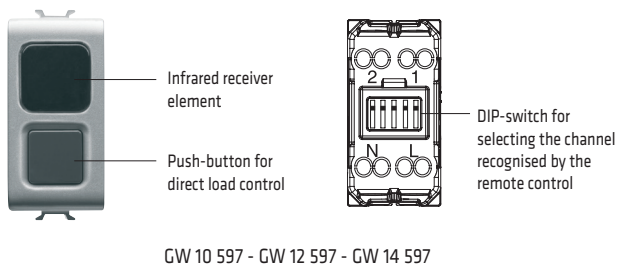

TECHNICAL DATA	
Rated voltage	230V AC 50/60 Hz
Output contact	1 NO 5A (AC1) 250V AC
Wiring terminals	
Power supply: L - Phase N - Neutral	
Potential-free output: 1 / 2 NO contact (monostable)	

Installation characteristics

Fields of use: • Buildings in the domestic or advanced commercial sector, where you want to obtain a high level of comfort • Renovations where it would be harsh or ugly to install terminal control circuits • Places for the disabled.

LOAD COMMAND	JOGGING COMMAND OF LOADS	COMMAND AND ADJUSTMENT OF RESISTIVE AND INDUCTIVE LOADS
Command of user devices via relay connected to the infrared receiver. (e.g. GW 10 721 - GW 12 721 - GW 14 721)	Jogging command of user devices such as electro-locks or ringers. (e.g. GW 10 602 - GW 12 602 - GW 14 602)	Command and adjustment of lighting devices connected to a dimmer. (e.g. GW 10 568 - GW 12 568 - GW 14 568)

Latching relay

Electromechanical relay (of the latching type) for commanding lamps from more than one point.

Reference standards: EN 60669-1;EN 60669-2-2

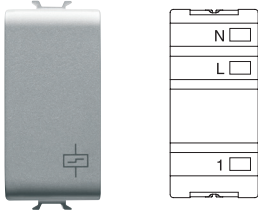

Wiring terminals

Power supply:

L - Phase
N - Neutral

230V AC output:

1 - Load power supply contact

GW 10 721 - GW 12 721 - GW 14 721

TECHNICAL DATA	
Power supply voltage (coil)	230V AC 50/60 Hz
Output contact	10AX 250V AC
Number of poles	1

Connection diagram

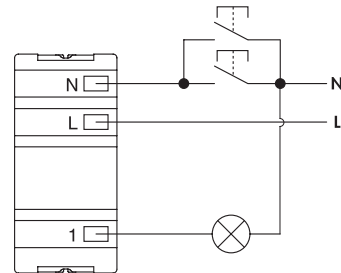

4 sequence latching relay

Electromechanical relay with 4 sequences for commanding two independent circuits, in the sequence: open-open, open-closed, closed-open, closed-closed.

Reference standards: EN 60669-1;EN 60669-2-2

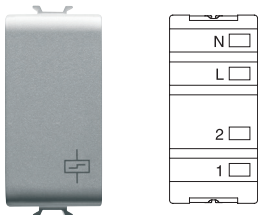

Wiring terminals

Power supply:

L - Phase
N - Neutral

230V AC output:

1 - Contact 1
2 - Contact 2

GW 10 723 - GW 12 723 - GW 14 723

TECHNICAL DATA	
Power supply voltage (coil)	230V AC 50/60 Hz
Output contact	10AX 250V AC
Number of poles	2

NUMBER OF IMPULSES	SEQUENCES			
	1	2	3	4
4				

Momentary relay

Electromechanical momentary relay suitable for creating automatism or separations between the command circuit and the energy circuit. Can be used as an auxiliary element for controlling special loads.

Reference standards: EN 60669-1;EN 60669-2-2

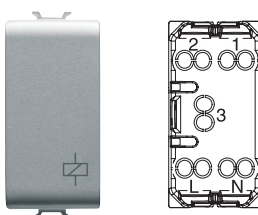

Wiring terminals

Power supply:

L - Phase
N - Neutral

Potential-free output:

1 - NC contact
2 - NO contact
3 - Common

GW 10 724 - GW 12 724 - GW 14 724

TECHNICAL DATA	
Power supply voltage (coil)	230V AC 50/60 Hz
Output contact	1 NO/NC 10A (AC1) /2A (AC15) 250V AC 50/60Hz
Number of poles	1

Connection diagram

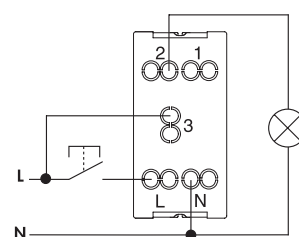

For technical information contact the Technical Assistance Service or visit gewiss.com

Call relay

“Bathroom Alarm” call system

Since each Country establishes its own technical regulations in order to avoid architectural barriers, here below is represented only an example for the creation of hygiene services for people with a disability.

From the electrical point of view, in particular there must be an emergency bell located near the toilet and the bath.

The alarm circuit must be activated by means of a pull-cord push-button (emergency bell) which, if pressed again, does not silence the alarm.

The return to a condition of normality can only be obtained by pressing a remote push-button connected to the “reset” input of the relay.

In order to avoid the unintentional resetting of the alarm, the use of the key push-buttons (e.g. code GW 10 145, GW 12 145 and GW 14 145) is recommended.

Apart from the inputs for the “AL” alarm push-button and the “R” reset push-button, the Gewiss call relay, powered at 12V AC/DC, also includes an NO + NC output contact with 12V potential for managing acoustic/light signalling.

Reference standards: EN 60669-1;EN 60669-2-2

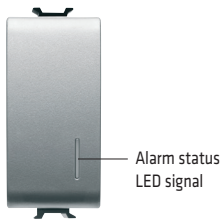

GW 10 726 - GW 12 726 - GW 14 726

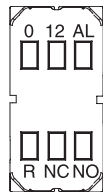

Wiring terminals

12V power supply: 0 / 12

Inputs:

AL - alarm push-button
R - reset push-button

12V output contacts:

NO - normally open contact
NC - normally closed contact

TECHNICAL DATA	
Power supply voltage (coil)	12V AC/DC
Output contact	1 NO/NC 1A 12V DC

Connection diagram

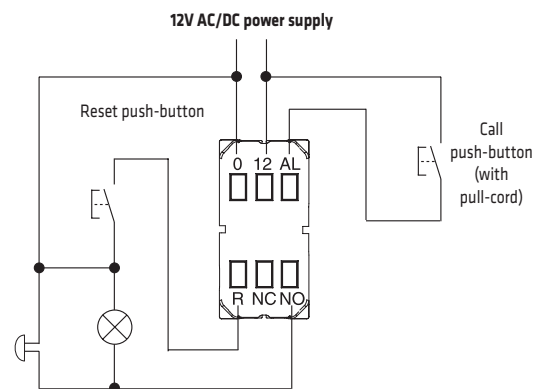

SOCKET-OUTLETS

Multistandard socket-outlets

The multistandard socket-outlets accept different types of plugs, guaranteeing always the right connection. They are provided with safety shields and are suitable for use in environments such as hotels, airports, meeting rooms, etc.

Reference standards: IEC 60884-1



GW 10 310 - GW 12 310 - GW 14 310

TECHNICAL DATA	
Type of socket-outlet	2P+E - 13A/250Vac - 15A/127Vac with safety shields
Terminal block	with screws (for rigid and stranded cables) up to 14mm ²)
Protection degree	IP20
Plugs compatibility	Europlug 2P 2.5A - 250V British 2P+E 13A - 250V Italian 2P 10A - 250V Danish 2P 10A - 250V Chinese 2P+E 10A - 250V Argentinean/Australian 2P+E 10A - 250V Indian 2P+E 6A - 250V USA 2P+E 15A - 127V Not suitable for 2P+E German and French sockets because they don't offer earth continuity
Dimensions	2 Chorus modules

NOTES: the multistandard energy sockets GW10310, GW12310, GW14310 are in compliance with the safety requirements defined by the International Standard IEC 60884-1. These sockets may not be in compliance with the standard sheets used in the country where they are sold, hence their usage could be prohibited or however, restricted only for specific applications. The plugs allowed are listed in the technical datasheet. Please contact directly Gewiss technical service for further information.

SOCKET-OUTLETS

Italian and international standards

Italian		<p>Power supply for household appliances, lighting devices, portable appliances, etc. Multiple sockets to reduce wiring times.</p>
		<p>Power supply of equipments through dedicated lines.</p>
Italian/German		<p>Power supply for household appliances, lighting devices, portable appliances, etc.</p>
		<p>Power supply of equipments through dedicated lines.</p>
German		<p>Power supply for household appliances, lighting devices, portable appliances, etc. Sockets provided with a IP40 transparent lid.</p>
		<p>Power supply of equipments through dedicated lines.</p>

<p>French</p>		<p>Power supply for household appliances, lighting devices, portable appliances, etc.</p>
		<p>Power supply of equipments through dedicated lines.</p>
<p>British</p>		<p>Power supply for household appliances, lighting devices, portable appliances, etc.</p>
<p>Main international standards: USA, Euroamerican, Israeli, Argentinian, Australian, Chinese, etc.</p>		<p>Power supply for household appliances, lighting devices, portable appliances, etc.</p>

German and french standard sockets with front tightening of terminals

The German and French Standard sockets with front tightening of terminals allow you to check the correct fixing of the cables once the installation is completed and, thanks to the side output, they also allow a reduced bulk of the wiring in the box (flush-mounting or surfacemounting).

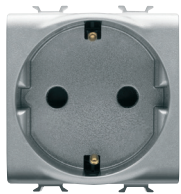

GW 10 341
GW 12 341
GW 14 341

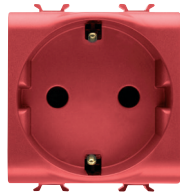

GW 10 351



GW 10 248
GW 12 248
GW 14 248



GW 10 258

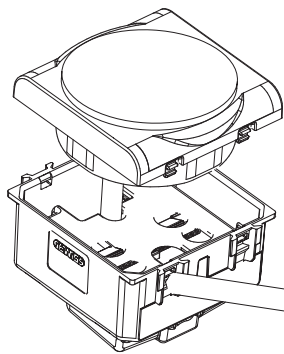

To access the front-fixing terminals of the sockets, it is necessary to remove the lid with the help of a screwdriver

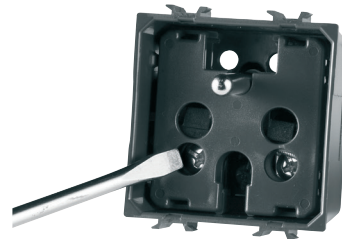

Terminal tightening screws

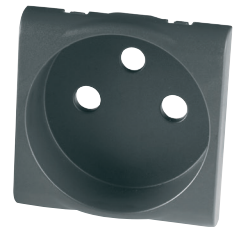

Removable front lid

French standard socket for allocated lines, with front tightening terminals



GW 10 258



GW 10 260

This French Standard socket allows you to identify and privilege an energy take-off point, in order to prevent the powering of devices excluded from the allocated line. The sockets are equipped with a supplementary honeycomb for the mechanical release of the safety shields. The plugs of the services connected to these circuits require the accessory (GW 10 260) which, when fixed on the front of the plug, allows you to unblock the protection system.

Plugs and sockets for dedicated lines

Functional characteristics

The plugs and sockets for dedicated lines allow the clear differentiation of a power outlet intended for special applications, avoiding the connection of services not envisaged for this circuit.

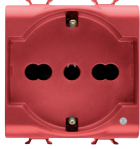

APPLICATION EXAMPLES*:

Red:
Line fed by UPS static system

→



If the sockets installed inside the same box have different power supply lines, separate the circuits by mean of the special divider.

Green:
Line fed by mains power supply/generating set

→

If the sockets installed inside the same box have different power supply lines, separate the circuits by mean of the special divider.

Orange:
Line powered by mains/generator and insulation transformer

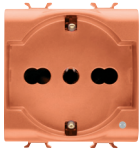
→

If the sockets installed inside the same box have different power supply lines, separate the circuits by mean of the special divider.

* There are no relevant regulatory provisions, therefore the examples of colour use are only a guide.

Euro-american standard shaver socket with insulation transformer

The shaver socket includes a powered insulation transformer 20VA, automatically fed upon the insertion of the plug. There is also a selector that allows you to change the voltage of the secondary circuit of the transformer. Especially suitable for use in hotel facilities.

Reference standards: EN 61558-2-5

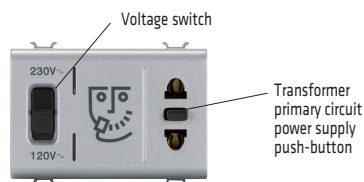

GW 10 331 - GW 12 331 - GW 14 331

TECHNICAL DATA	
Insulation transformer in compliance with CEI 96-1 standards:	Primary: 230V ac
	Secondary: 120 and 230V ac
	Frequency: 50/60Hz
	Power: 20 VA
Euro-American 2P socket suitable for:	Overload protection via PTC with automatic reset
	American standard plugs 6.3 x 1.5
	Centre distance 12.7mm
	British 2.5A Standard plugs (plug pins Ø 5mm)
	European plugs 2.5A
Italian Standard plugs 2 x 10A - type S10	

For technical information contact the Technical Assistance Service or visit gewiss.com

Interlocked switched socket-outlets

Many danger situations in the domestic environment are caused by faults or insulation leaks in the service devices (especially the portable ones), occurring when the appliance is fed.

Gewiss has created interlocked switched socket-outlets with a bipolar switch (both miniature circuit breaker and residual current circuit breaker with overcurrent protection), suitable for installation in the system terminations for load protection. These socket-outlets guarantee that the holes are only connected to the voltage when the plug is inserted, to prevent the formation of electrical arcs when the plug is inserted and removed.

The automatic circuit breaker is immediately disconnected when the plug is pulled out.

Reference standards: CEI 23-50 (IEC 60884-1), EN 60898, EN 61009-1

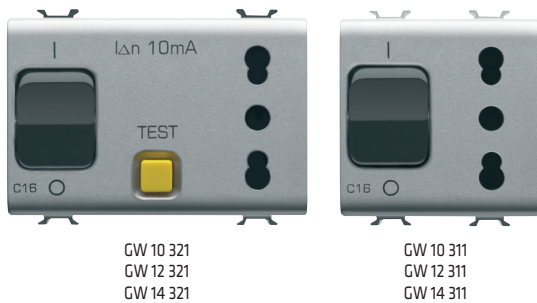

GW 10 321
GW 12 321
GW 14 321

GW 10 311
GW 12 311
GW 14 311

TECHNICAL DATA	
Power supply voltage	230V AC
Rated current	16A
Breaking capacity	3 kA
Rated residual current	10mA
Characteristic of the miniature circuit breaker tripping	C characteristic
Type of residual current devices	Class A
Number of poles	1P + N / 1P
Type of socket-outlet	2P + E 16A dual amperage 2P + E 16A dual amperage, Italian/ German Standard



1- the absence of voltage on the holes is ensured.



2- only with the plug completely inserted is it possible to close the circuit breaker.



3- the circuit breaker opens automatically when you begin to remove the plug.



4- protection is guaranteed in the event of short-circuiting/overloading and (where a residual current circuit breaker is envisaged) also in the event of direct or indirect contact.

Tripping characteristics

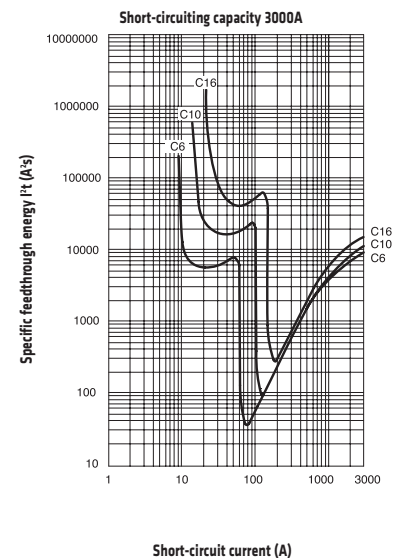
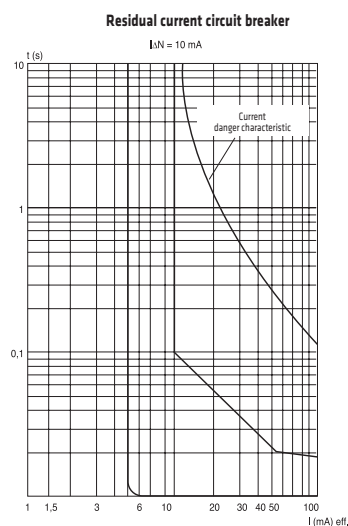
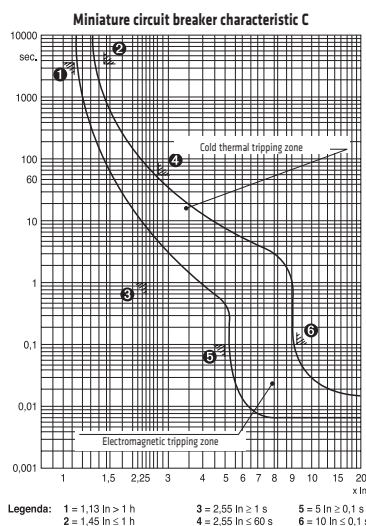

Key:

For technical information contact the Technical Assistance Service or visit gewiss.com

SIGNAL

TV-SAT socket-outlets

The development of television transmission systems and of services intended for the user has raised the performance and quality level required for signal distribution systems.

The EN 60728 standards (systems for distribution of television and sound signals via cable) define the present and future European standard and establish the requisites that the various parts of the system (including the terminal socket-outlets) must meet.

Thanks to their high performance level, these socket-outlets offer optimal distribution of the signals, both digital and analogue, as required by the various drivers for access to present and future services.

CHARACTERISTICS	ADVANTAGES
<ul style="list-style-type: none"> Shielding efficiency (in compliance with standard EN 60728-4). 	<ul style="list-style-type: none"> The socket-outlets are in a metal shell and are unaffected by the electromagnetic emissions (EMC) present in the environment.
<ul style="list-style-type: none"> Impedance adaptation. System for the quick and safe connection of the coaxial cable. 	<ul style="list-style-type: none"> Undesired signal reflections are avoided. Maintains the co-axiality of the cable in the connection point.
<ul style="list-style-type: none"> A range featuring two types: user ports with F connector (type EN 60169-24) and with male IEC connector Ø 9.5mm (in compliance with HD134.2 S2). 	<ul style="list-style-type: none"> Maximum application flexibility with single or centralised systems (new / restored / arrangements for future extensions). In satellite reception, due to the frequency range, it is very important to maintain the co-axiality of the connection, which is a requirement fully met by the innovative connection and the use of the F connector.

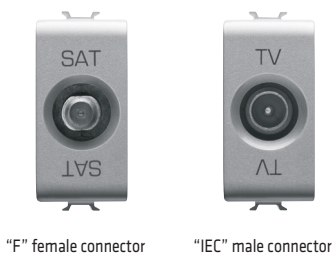
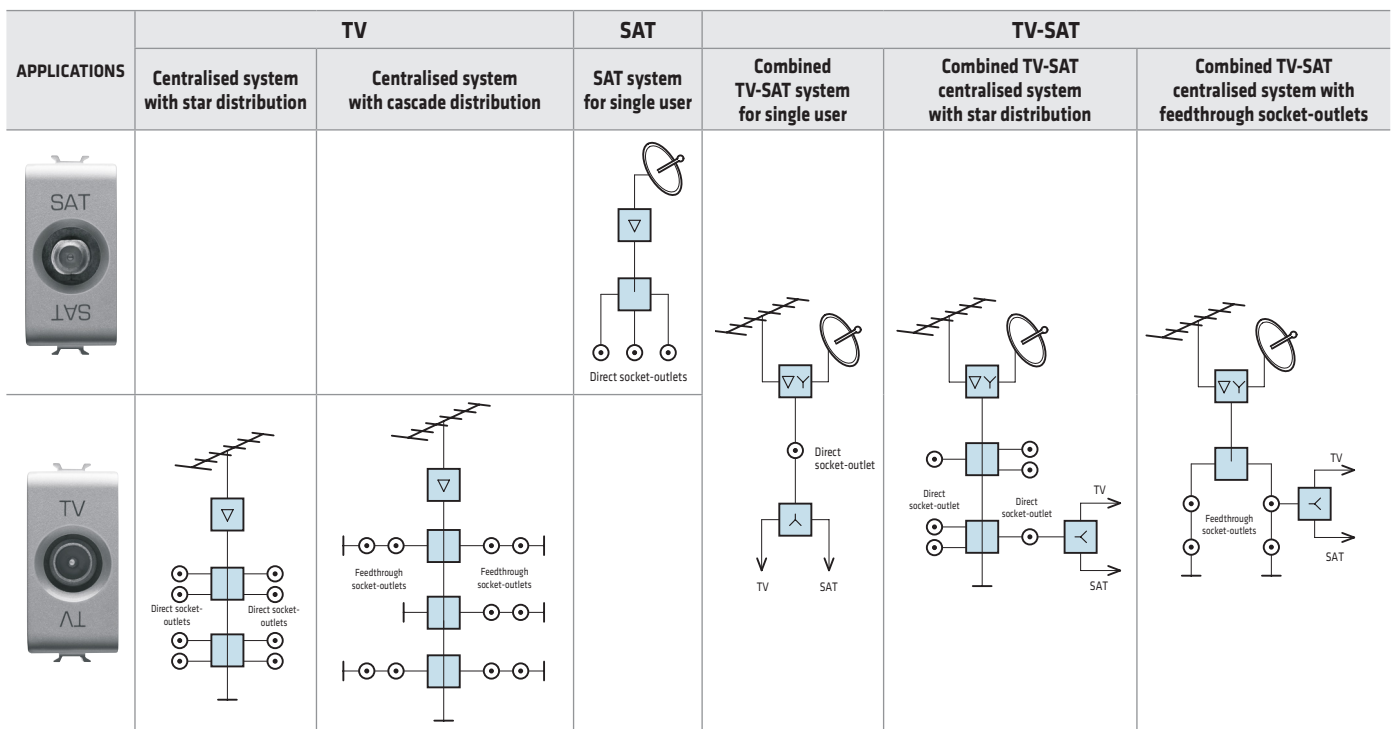

TECHNICAL DATA	
Frequency field	From 5 to 2400 MHz
Diameter of the coaxial cable	From Ø 5 to Ø 7mm
Return channel	From 5 to 40 MHz
Shielding	Class A
Chrominance/luminance delay difference	< 1 ns. for all models
User port - TV socket-outlet	Male IEC coaxial connector Ø 9.5mm
User port - TV-SAT socket-outlet	F coaxial connector (female)

For technical information contact the Technical Assistance Service or visit gewiss.com

TV-FM-SAT socket-outlets

The TV-FM-SAT socket-outlets of 2 modules allow the contemporary connecting of more than one device. The socket-outlets consist of:

- male IEC coaxial TV socket-outlet connector
- female F coaxial TV-SAT socket-outlet connector
- female IEC radio socket-outlet connector

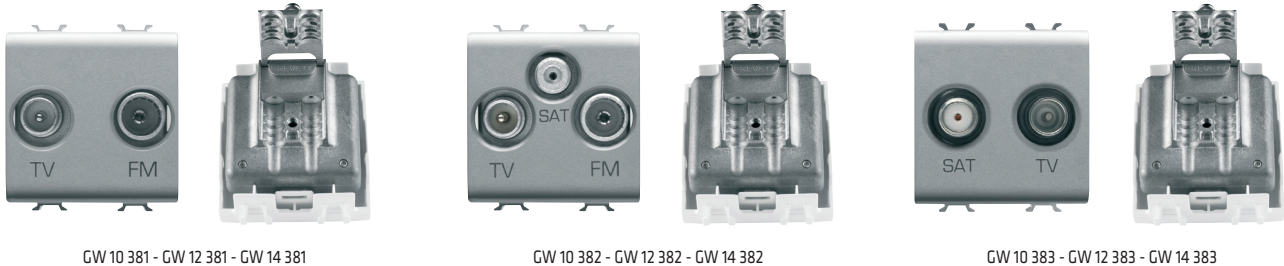

Code	Type of socket-outlet	Cut-out attenuation (base loss)	Insulation (average value between the ports)	Return loss (input port)			Current passage		
				Return channel 5-40 MHz.	TV 47-862 MHz.	SAT 950-2400 MHz.	TV	FM	SAT
GW 10-12-14 381	TV - FM	<1.5 dB	>22 dB	>18 dB	>10 dB	-	-	-	-
GW 10-12-14 382	TV-FM-SAT	<2.5 dB	>20 dB	>10 dB	>10 dB	>12 dB	-	-	500mA
GW 10-12-14 383	TV-SAT	<1.5 dB	>25 dB	>10 dB	>10 dB	>10 dB	-	-	500mA

International Standard telephone connectors

RJ11 telephone connector with 4 contacts, suitable for connecting the telephone, telefax, modem.



RJ11:
RJ11 IN-OUT: GW 10 401 - GW 12 401 - GW 14 401
GW 10 402 - GW 12 402 - GW 14 402



RJ11 DOUBLE: GW 10 403 - GW 12 403 - GW 14 403

Reference standards: ISO 11801

RJ11 CONNECTOR	RJ11 IN-OUT CONNECTOR	RJ11 DOUBLE CONNECTOR
<p>The RJ11 connector is provided with a dust cover and terminal blocks with screws.</p>	<p>The RJ11 IN-OUT connector offers the possibility to connect an input line and an output line, quickly and easily. The divided terminal block avoids the use of additional terminals, and facilitates the wiring operations. Fixing of cable on insulation perforating terminals.</p>	<p>The RJ11 double connector offers 2 RJ11 connectors in a single module. The double rear terminal block facilitates the wiring operations. Fixing of cable on insulation perforating terminals.</p>

Series connection

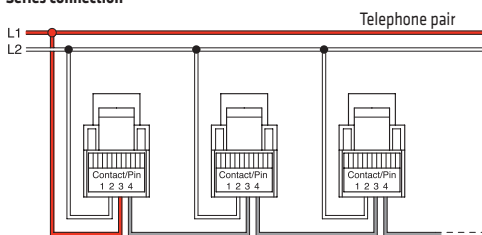

• The clamps 3 and 4 are connected by means of the contact inside the telephone, which is closed when the telephone receiver is put down. When the telephone receiver is picked up, the line breaks downstream (L1 pole), ensuring that the conversation is not overheard.

Note: with the connection in series, when one of the plugs is extracted, the socket-outlets positioned downline are disconnected. To prevent this problem, just insert a plug with a jumper between terminals 3-4, in the socket-outlets from which the telephone appliance was removed.

Parallel connection

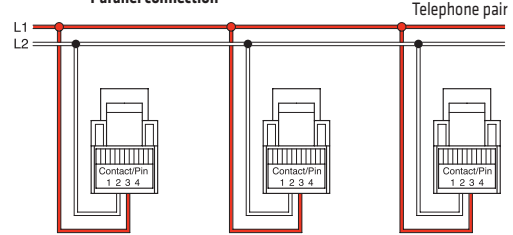

• Each socket-outlet takes the signal from the line. There is no privacy of conversation.

For technical information contact the Technical Assistance Service or visit gewiss.com

Connectors for structured wiring

RJ45 connectors of category 5e and 6, shielded (FTP) and unshielded (UTP), for data transmission. Allow computerised devices (computers, printers, modems, etc.) to be connected to the network, as well as the connection of multimedia devices (e.g. videoconference facilities). They can also be used for traditional, centralised telephone systems.

Diagrams

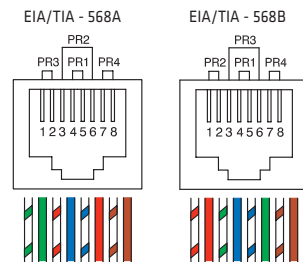

To obtain the EIA/TIA 568A or 568B configuration shown alongside, follow the colour code given on the terminal block (of the products).

Toolless connection

With the Toolless connection, it is possible to make the connection without using additional tools. This connection simplifies the wiring operations.

Reference standards: EN 50 173 - ISO 11801 EIA / TIA 568A

CAT 5e



GW 10 421 - GW 12 421 - GW 14 421
GW 10 422 - GW 12 422 - GW 14 422

CAT 6



GW 10 423 - GW 12 423 - GW 14 423
GW 10 424 - GW 12 424 - GW 14 424

ADAPTERS



GW 10 431 - GW 12 431 - GW 14 431

The wires without fitted terminal are inserted in the appropriate blade seats. The cover closure ensures the complete incision of the insulation and the electrical continuity with the contact.

Suitable for Keystone Jack-type connectors (manufactured in according to standard EN 60603-7)

TECHNICAL DATA	GW 10 421	GW 10 423
	GW 12 421	GW 12 423
	GW 14 421	GW 14 423
Connector type	RJ45	
Type of cables used	UTP	
No. of contacts	8	
Terminals	toolless	
Category	5e	6
Transmission protocols used	EIA/TIA 568A - EIA/TIA 568B	

TECHNICAL DATA	GW 10 422	GW 10 424
	GW 12 422	GW 12 424
	GW 14 422	GW 14 424
Connector type	RJ45	
Type of cables used	FTP	
No. of contacts	8	
Terminals	toolless	
Category	5e	6
Transmission protocols used	EIA/TIA 568A - EIA/TIA 568B	

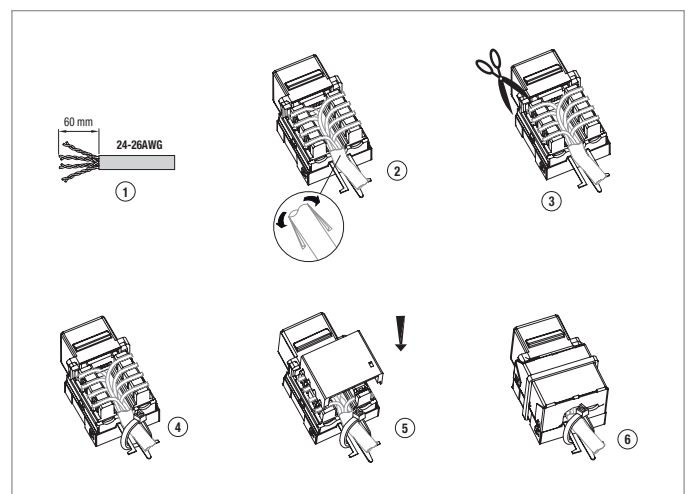
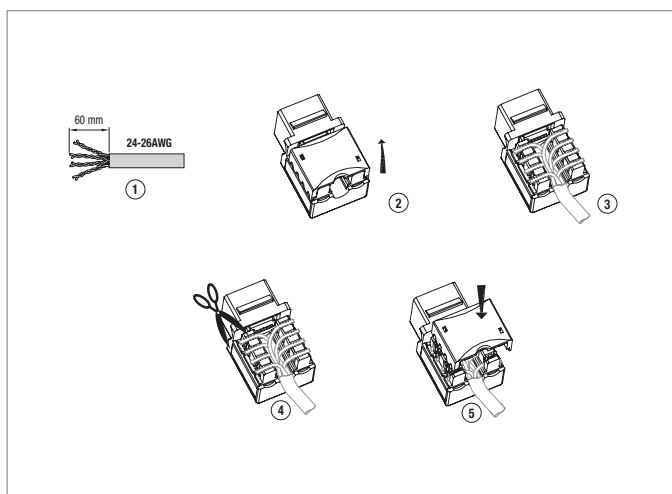

USB and HDMI couplers

Female-female couplers with Keystone Jack coupling, for A-type USB and HDMI cables. To complete with GW1x431 adapters.

HDMI coupler



GW 38 056

USB coupler



GW 38 057

USB charger

2.1A double USB charger, suitable for powering mobile phones, smartphones and mobile electronic devices.

Double USB charger



GW 10 450
GW 12 450 - GW 14 450



TECHNICAL DATA	
Power supply	100-240V ac - 50/60Hz - 300mA max
Output	5V dc - 2,1A
USB connector	Type A 2.0
Power supply connector	Screws terminals, maximum cable section 1,5mm ²
Degree of protection	IP20
Operating temperature	0÷ +40°C

Suitable to recharge a single 2.1A electronic device or a couple of simultaneous devices. The total current provided (max. 2.1A) is split in the two USB outputs, depending on the state of charge of the connected devices.

Connector for speakers/music

Front terminals (red and black) for inserting solid or stranded cables with section max 1.5mm². Rear dual puncture insulation terminals for AWG24 cables or for cables with section max 0.25mm² (an "impact tool" like GW38051 is recommended).



GW 10 458
GW 12 458
GW 14 458

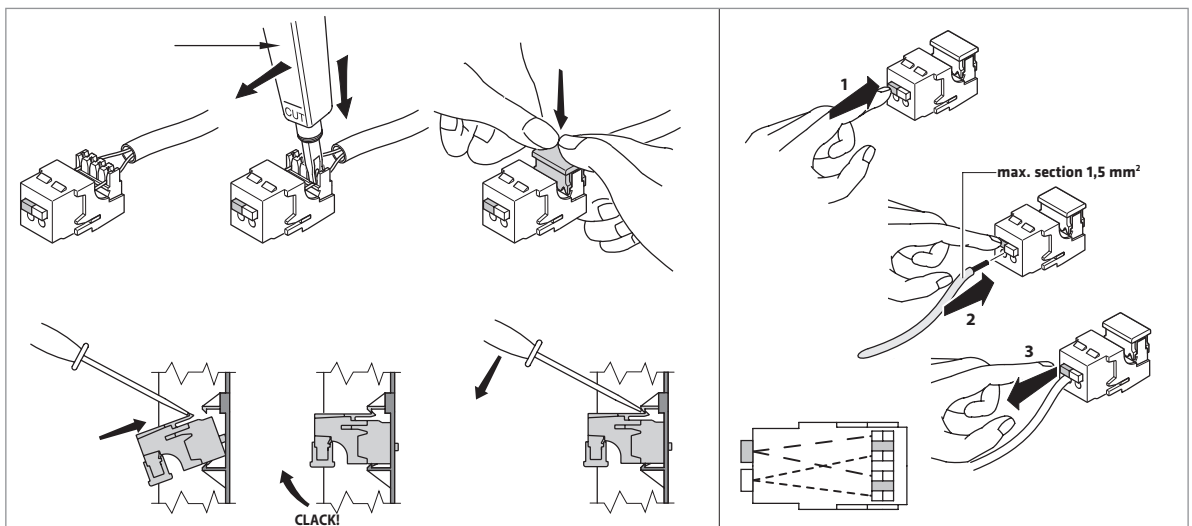

PROTECTION

Automatic circuit breakers

The automatic circuit breakers protect the electrical load connected downline (either directly or via a socket-outlet) against overloading and short-circuiting and, via the residual current circuit breaker part, against contact voltages. They can be installed together with the miniature circuit breakers and the RCCBs with overcurrent protection used - in the enclosure of the home - to diversity the different lines while respecting the selectivity.

They are particularly suitable in locations where there is a high risk of electrocution, such as the bathroom, to protect terminal devices, as well as a safety for portable service devices in the home and so on.

Miniature circuit breaker tripping with C characteristic and A-type residual current circuit breaker for alternated fault currents and single-direction push-buttons.

Reference standards: EN 60898-1; EN 61009-1; EN 61543



Miniature circuit breaker



RCCB with overcurrent protection

TECHNICAL DATA						
	Power supply voltage	Number of poles	Rated current	Breaking capacity		Code
Miniature circuit breaker	230V AC	1P	6A	3 kA		GW 10 461 - GW 12 461 - GW 14 461
			10A			GW 10 462 - GW 12 462 - GW 14 462
			16A			GW 10 463 - GW 12 463 - GW 14 463
		1P+N	6A			GW 10 466 - GW 12 466 - GW 14 466
			10A			GW 10 467 - GW 12 467 - GW 14 467
			16A			GW 10 468 - GW 12 468 - GW 14 468
RCCB with overcurrent protection	230V AC	1P+N	6A	3 kA	10mA	GW 10 482 - GW 12 482 - GW 14 482
			10A			GW 10 485 - GW 12 485 - GW 14 485
			16A		GW 10 488 - GW 12 488 - GW 14 488	
			30mA		6A	GW 10 483 - GW 12 483 - GW 14 483
					10A	GW 10 486 - GW 12 486 - GW 14 486
					16A	GW 10 489 - GW 12 489 - GW 14 489

Tripping characteristics

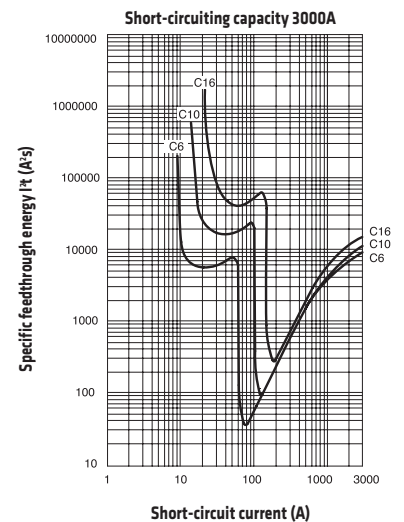
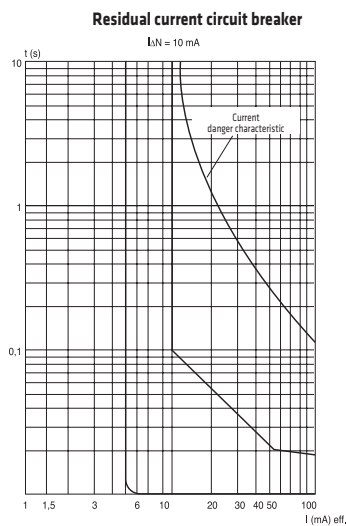
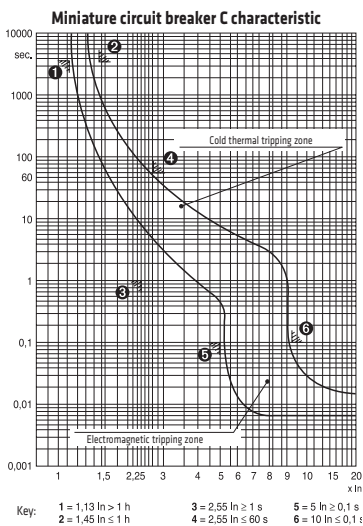

For technical information contact the Technical Assistance Service or visit gewiss.com

Overvoltage limiter

The overvoltage limiter is a discharger of the varistor type, suitable for protecting the power supply socket-outlets of all types of electrical appliances (especially those containing electronic components, e.g. TV, DVD player, hi-fi, etc.) from damage that can arise from the presence of overvoltages induced in the mains by manoeuvres or atmospheric discharges. The overvoltage peak will not reach the service, or will at least be greatly attenuated. If the varistor should break, the presence of a fuse prevents short-circuiting. The failure is signalled by the switching off of the LED, and the lack of power supply.

Reference standards: EN 61643-11

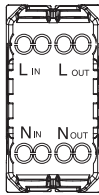

Connection terminals

Input line: L in - Phase
N in - Neutral

Output line: L out - Phase
N out - Neutral

GW 10 492 - GW 12 492 - GW 14 492

TECHNICAL DATA	
Rated voltage	250V AC
Uc	275V AC 50/60 Hz
Up	1kV
Uoc	<= 2.5 kV

Connection diagram

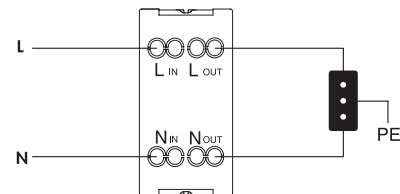

The Gewiss range to protect circuits against overvoltage in the domestic or similar environments includes the dischargers in the POWER catalogue, designed for installation in home enclosures.

Fuse holder

Modular element for the installation of fuses (\varnothing 6.3x32mm) with a maximum rated current of 16A.

Socket-outlets should be included upline, to power devices for which additional protection against overcurrents and short-circuiting is recommended. Especially suitable for the protection of dimmers too. The fuse is not included.



Connection diagram

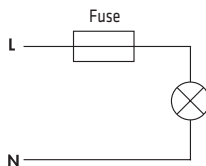

GW 10 491
GW 12 491 - GW 14 491

TECHNICAL DATA	
Rated voltage	230V AC
Maximum rated current	16A
Number of poles	1
Fuses that can be inserted	\varnothing 6.3 x 32mm

SIGNALLING

Extractable anti-blackout lamp

Lamp with high efficiency LED, to be inserted in any Italian, German or French Standard socket-outlet, suitable for auxiliary lighting in the event of a mains failure; can be easily extracted and used as a normal, portable, rechargeable lamp. Selecting the “night” function, it can be used as a courtesy night-light; when in this mode, the lamp switches off automatically after about 30 minutes. The time necessary for recharging is about 36 hours.

Signalling LED:

- green: indicates the presence of the mains
- red: indicates the inhibition of the anti-blackout function



Reference standards: EN 60065; EN 61000-6-3; EN 61000-6-1



GW 10 661 - GW 12 661 - GW 14 661

By means of a front selector, the lamp can work in different modes:

- emergency: switches on automatically when there is no mains voltage
- inhibition: lamp always switched off
- night: the lamp remains switched on for about 30 minutes, powered by batteries, then switches off and recharges automatically

TECHNICAL DATA	
Power supply voltage	230V AC
Battery	Ni-Mh 3.6V 80mAh
Minimum autonomy	2 hours
Recharging time	36 hours
Lamp	High efficiency LED
Power absorbed in standby mode	2W

Socket-outlet type	Socket-outlet code (example)	GW 1x 661 lamp ledge (measured from the socket-outlet surface)
Italian standard	GW 1x 203	42 mm
Italian/german standard	GW 1x 204	30 mm
German standard	GW 1x 241	24 mm

Flush-mounting anti-blackout lamp

Flush-mounting anti-blackout lamp, 1 Chorus module, suitable for auxiliary lighting in the event of a mains failure. Front LED indicating presence of mains and standby (steady green light).



GW 10 662 - GW 12 662 - GW 14 662

TECHNICAL DATA	
Power supply voltage	230V AC
Battery	Ni-Mh
Minimum autonomy	1 hour
Recharging time	12 hours
Lamp	White high efficiency LED
Dimensions	1 Chorus module

Autonomous emergency lamps

Autonomous emergency lamps for flush-mounting boxes of 2 and 4 modules, suitable for emergency lighting in residential or public service environments when there is no mains voltage. A green frontal LED indicates the presence of mains voltage. Can be used to light exits, dangerous passages, etc. The lighting uses a high efficiency white LED.

Reference standards: EN 60598-2-22



GW 10 663 - GW 12 663
GW 14 663



GW 10 666 - GW 12 666
GW 14 666

TECHNICAL DATA	GW 1x 666	GW 1x 663
Power supply voltage	230V AC	230V ac
Battery	Ni-Mh 3.6V 1100mAh	Ni-Mh 3,6V 160mAh
Minimum autonomy	1 hour	1 hour
Recharging time	24 hours	12 hours
Lamp	1 white high efficiency LED	2 white high efficiency LED
Power absorbed in standby mode	1W	1W
Dimensions	4 Chorus modules	2 Chorus modules
Light flux	30 lumens	12 lumens

Indicator lamps

Permit the visualisation from a considerable distance of the ON/OFF status of a service or lighting circuit. The Chorus half-module indicator lamps allow notable space-saving.

The indicator lamps must be completed with miniature lamps with wired lead, to be inserted in the back of the product

Reference standards: EN 62094-1



1/2 Module
GW 10 641 - GW 12 641 - GW 14 641 Opal
GW 10 642 - GW 12 642 - GW 14 642 Green
GW 10 643 - GW 12 643 - GW 14 643 Red
GW 10 644 - GW 12 644 - GW 14 644 Amber

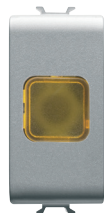

1 Module
GW 10 621 - GW 12 621 - GW 14 621 Opal
GW 10 622 - GW 12 622 - GW 14 622 Green
GW 10 623 - GW 12 623 - GW 14 623 Red
GW 10 624 - GW 12 624 - GW 14 624 Amber



1 Module
GW 10 628 - GW 12 628 - GW 14 628 Opal/opal
GW 10 629 - GW 12 629 - GW 14 629 Red/green

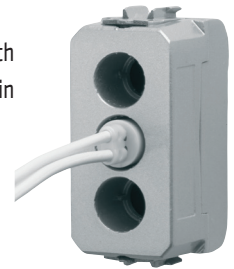

Protruding indicator lamps

Permit the visualisation from a considerable distance of the ON/OFF status of a service or lighting circuit. The light generated by the indicator lamp is visible not only from the front, but also from the side. Suitable for special applications such as the signalling of calls from hospital wards. The protruding indicator lamps are supplied with LED sources.

Reference standards: EN 62094-1

TECHNICAL DATA	
Power supply voltage	12V AC/DC or 230V AC
Dimensions	2 Chorus modules
Type of lamp	LED
Power absorbed	12V: 0.4W - 230V: 6W



GW 10 631 - GW 12 631 - GW 14 631
Opal



GW 10 632 - GW 12 632 - GW 14 632
Green

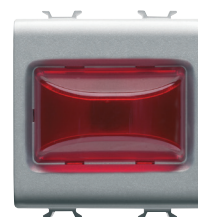

GW 10 633 - GW 12 633 - GW 14 633
Red

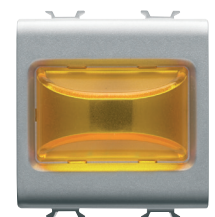

GW 10 634 - GW 12 634 - GW 14 634
Amber

Stair riser lamp

Lamp with white LEDs, suitable for use as a stair riser lamp, courtesy lamp, night-time lamp, etc.
 The product has a double 12V AC/DC - 230V AC power supply input.
 The lamp with white LEDs is integrated in the product.

Reference standards: EN 62094-1



2 Chorus modules
 GW 10 651 - GW 12 651 - GW 14 651



4 Chorus modules
 GW 10 656 - GW 12 656 - GW 14 656

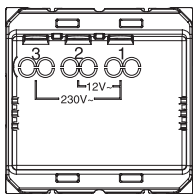

Wiring terminals

Power supply: terminals 1-2: 12V
 terminals 1-3: 230V

TECHNICAL DATA	
Power supply voltage	12V AC/DC or 230V AC 50/60Hz
Dimensions	2-4 CHORUS modules
Type of lamp	White high efficiency LEDs
Power absorbed	12V 2 modules: 0.12W 230V 2 modules: 0.6W 12V 4 modules: 0.1W 230V 4 modules: 0.5W

Ringer with three independent inputs

The ringer with three independent inputs has three different acoustic signals:

- emergency-type sound (e.g. bathroom alarm)
- two-tone sound (e.g. main entrance ringer)
- trill-type sound (e.g. secondary entrance ringer)

The volume of the ringer can be adjusted using the push-button on the back.

Reference standards: IEC 62080

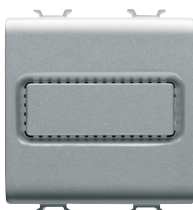

GW 10 611 - GW 10 612
 GW 12 611 - GW 12 612
 GW 14 611 - GW 14 612

TECHNICAL DATA	
Power supply voltage	GW 10 611 - GW 12 611 - GW 14 611 12V AC/DC GW 10 612 - GW 12 612 - GW 14 612 230V AC - 50Hz
Dimensions	2 CHORUS modules
Power absorbed	GW 10 611 - GW 12 611 - GW 14 611 3 VA GW 10 612 - GW 12 612 - GW 14 612 6 VA
Sound intensity	80dB at 1m

Wiring terminals

Power supply: L - Phase
 N - Neutral

Ringer inputs: 1 - emergency
 2 - two-tone
 3 - trill

Connection diagram

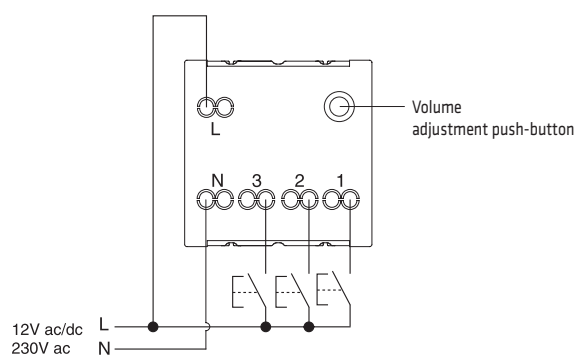

For technical information contact the Technical Assistance Service or visit gewiss.com

ENERGY AND COMFORT MANAGEMENT

1-channel daily and weekly electronic timer

- Electronic device for the timed command of a load
- Positive LCD display with white backlight
- Permanent indication of: time, day of the week, load lighting status, functioning/working mode status,
- 144 daily cycles that can be set (transitions every 5 minutes)
- Manual activation/deactivation of the load (MAN mode)
- Programmed activation/deactivation of the load (AUTO mode), with daily/weekly cycles
- Permanent deactivation of the load (OFF mode)
- Immediate visualisation of the daily planning, via permanently visualised histogram
- Rechargeable buffer battery

Reference standards: EN 60730-1; EN 60730-2-7



Chorus: GW 10 581 - GW 12 581 - GW 14 581

Command push-buttons:

- Selection of functional mode
- Selection of operational mode
- Modify (increase)
- Modify (decrease)

TECHNICAL DATA	
Power supply voltage	230V AC 50/60Hz
Output contacts	1NO/NC 8A(AC1) / 4A(AC15) 250V AC
Reserve charge	48 hours
Dimensions	2 modules
No. activations/deactivations	144

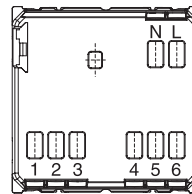

Wiring terminals

Power supply: L - Phase
N - Neutral

Output relay: 1 - NO contact
2 - NC contact
3 - Common

Serial line: 4 - TX (output data)
5 - GND (common)
6 - RX (input data)

Clock - Alarm - Thermometer

- LCD display with white backlight
- Visualisation of time (12/24h), day of the week and date
- Visualisation of the temperature
- Alarm function with two independent daily alarms
- Visualisation of the time programmed and the ringers activated
- "Snooze" function for the temporary silencing of the alarm
- Unit of temperature measurement can be selected (°C, °F)
- Rechargeable buffer battery

Reference standards: EN 60065; EN 55014-1; EN 55014-2



GW 10 708 - GW 12 708 - GW 14 708

TECHNICAL DATA	
Power supply voltage	230V AC
Dimensions	2 Chorus modules
Operating temperature	-5 to +45°C
Reserve charge	48 hours
Sound intensity	72 dB at 1m
Duration of temporary silencing	5 minutes
Temperature display field	0 to +45°C

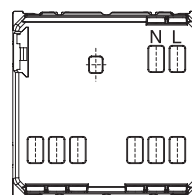

Wiring terminals

Power supply: L - Phase
N - Neutral

Electronic timer

The electronic timer allows you to command groups of light points or services, programming the automatic switching off after a pre-set period of time. On the device, there is a push-button for the command, and a LED that indicates the presence of mains voltage.

By means of a rotary selector on the side of the product, it is possible to vary the timing (15"-30"-45"-1'-1'30"-2'-3'-5'-10'-15').

Via the command circuit of the remote push-buttons connected, the device allows you to power up to 15 LED signalling units for localisation. 5 seconds before the end of the time period set, the device signals the imminent switching off by means of a brief deactivation of the load. Keeping the local push-button pressed for 5 seconds, you activate/deactivate the "stair cleaning" function: in this way, the load remains active for 30 minutes.

Reference standards: EN 60669-1, EN 60669-2-1



GW 10 583 - GW 12 583 - GW 14 583

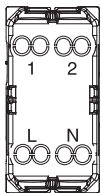

Wiring terminals

- Power supply:** L - Phase
N - Neutral
- Command:** 1 - Load
- Input:** 2 - Remote command

TECHNICAL DATA	
Power supply voltage	230V AC
Type of contact	Electronic TRIAC
Output contact	1 NO 2A (AC1) 250V AC
Fluorescent lamp command	not suitable
Dimensions	1 CHORUS module
Timer adjustment	15 seconds - 15 minutes
No. of push-buttons with remote access	15

Connection diagram

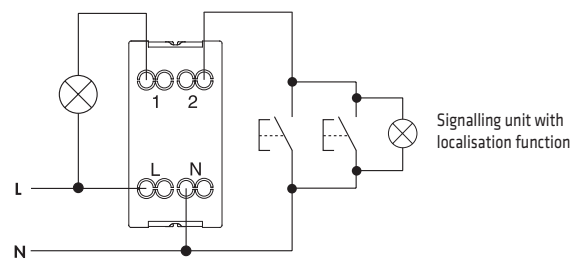

Relay timer

The relay timer is equipped with a front push-button for local activation, and is able to manage a series of light points or services, limiting their functioning time; it can also be used to command the extractor fan used in bathrooms, thereby avoiding a useless waste of electrical energy. The timer also has a LED that indicates the presence of mains voltage, and a rotary selector (beneath the easily removable front cover) to determine the duration of the load activation (15"-30"-45"-1'-1'30"-2'-3'-5'-10'-15').

Via the command circuit of the remote push-buttons connected, the device allows you to power up to 15 LED signalling units for localisation. Keeping the local push-button pressed for 5 seconds, the "stair cleaning" function (for modes 1 and 2) or the "forced fan" function (for 3 and 4) is activated/deactivated. In these modes, the load remains active for 30 minutes.

Reference standards: EN 60669-1, EN 60669-2-1



GW 10 582 - GW 12 582 - GW 14 582

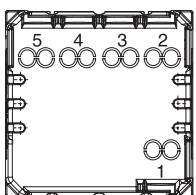

Wiring terminals

- Power supply:** 3 - Phase
2 - Neutral
- Potential-free output:** 4 / 5 NO contact
- Input:** 1 - Remote command

TECHNICAL DATA	
Power supply voltage	230V AC
Type of contact	relay
Output contact	1NO - 16A(AC1) / 4A(AC15) 250V AC
Fluorescent lamp command	max. 4A
Dimensions	2 CHORUS modules
Timer adjustment	15 seconds - 15 minutes
No. of push-buttons with remote access	15

Depending on the contact connection, it is possible to select one of the following operational modes:

- 1 - Timing with delay reset
- 2 - Timing without delay reset
- 3 - Delay in the stopping of the extractor fan after the switching off of the lamp (the extractor fan comes on when the lamp is switched on)
- 4 - The timed switching on/off of the extractor fan occurs after the light switches off.

For technical information contact the Technical Assistance Service or visit gewiss.com

DIMMER

Rotating electronic regulators, for resistive/inductive loads

Dimmer with conventional potentiometer adjustment and static switching off by turning the knob on position zero.

Reference standards: EN 60669-1, EN 60669-2-1

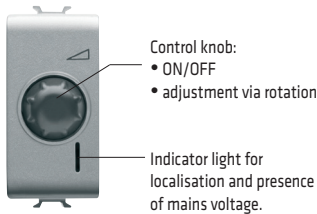

TECHNICAL DATA		
Product code	GW 10 561 - GW 12 561 - GW 14 561	GW 10 564 - GW 12 564 - GW 14 564 (*)
Technology	with TRIAC	with TRIAC
Power supply voltage	230V ac	230V ac
Max. power of resistive load	100 - 500W	100 - 900W
Max. power of inductive load		40 - 300VA
Adjustable load		
- Incandescent and halogen lamps	•	•
- Toroidal and lamellar transformers		•
Dimensions	1 Chorus module	1 Chorus module

(*) GW 10 564 - GW 12 564 - GW 14 564 - item designed solely to a limited number of countries outside the European Union or proposed as candidate and to the European Free Trade Association.

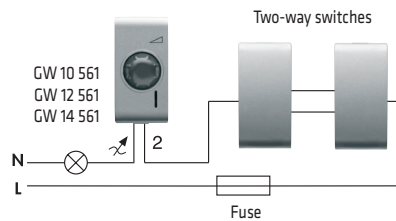
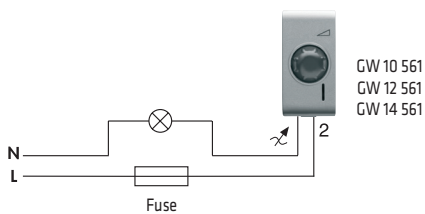

Typical use:

- Domestic sector for light source adjustment.

The conformity to EMC Directive is guaranteed only connecting the GW1x564 regulator to a LC filter as showed in the following wiring diagram.

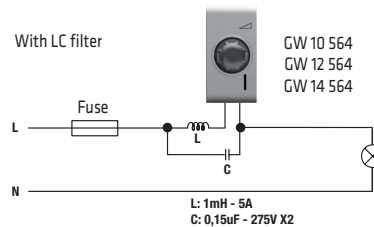
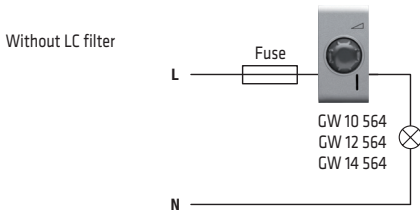

WARNINGS

- The connection should be made together with a fuse carrier (eg. GW1x491) with a quick-acting fuse with high breaking capacity type F2.5AH 250Vac (for GW1x561) or type F5AH 250Vac (for GW1x564) as shown in the diagrams.
- The regulator does not have a mechanical circuit breaker in the main circuit and so is not galvanically separated. The circuit load should be considered always under voltage.
- The conductors should be pushed down to the bottom of the box. Do not let the conductors in the box contact the walls of the regulator.
- Do not install the regulator near thermostats or chronothermostats.
- Max n.1 regulator in the same round/square box. Max n.2 regulators in the same rectangular box; for installations with 2 regulators in the same box, the maximum loads controllable by each regulator should be reduced by 50%. The side-by-side installation of several products in a single box is not permitted: insert a blanking module between two electronic devices.
- It should be used in dry, dust-free places at a temperature between 0 °C and +35 °C.

Rotating electronic regulators with two-way switch, for resistive/inductive loads

Dimmer with incorporated two-way switch that makes it possible to command the switching on and off of a second point (using the two-way switch), or a number of points (using intermediate switches). Switched on and off by pressing the knob; adjustment by turning it.

Reference standards: EN 60669-1; EN 60669-2-1

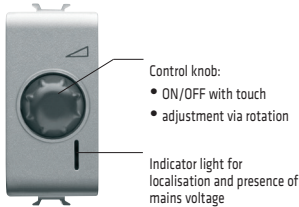

TECHNICAL DATA	
Product code	GW 10 567 - GW 12 567 - GW 14 567
Technology	with TRIAC
Power supply voltage	230V ac
Max. power of resistive load	100 - 500W
Max. power of inductive load	100 - 500VA
Adjustable load	
- Incandescent and halogen lamps	•
- Toroidal and lamellar transformers	•
Dimensions	1 Chorus module

Typical use:

- Domestic sector for light source adjustment.
- In existing systems, the dimmer with two-way switch can be easily installed in place of a two-way switch, without modifying the original circuit.

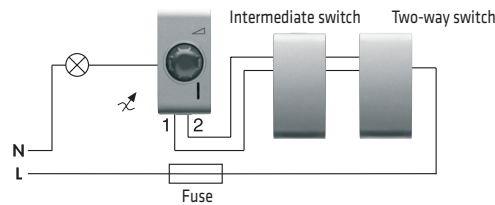
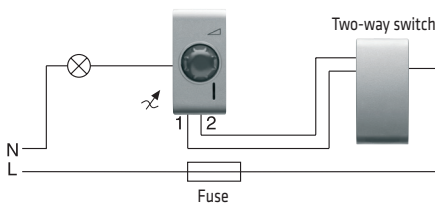

WARNINGS

- The connection should be made together with a fuse carrier (eg. GW1x491) with a quick-acting fuse with high breaking capacity type F2.5AH 250Vac as shown in the diagrams.
- The conductors should be pushed down to the bottom of the box. Do not let the conductors in the box contact the walls of the regulator.
- Do not install the regulator near thermostats or chronothermostats.
- Max n.1 regulator in the same round/square box. Max n.2 regulators in the same rectangular box; for installations with 2 regulators in the same box, the maximum loads controllable by each regulator should be reduced by 50%. The side-by-side installation of several products in a single box is not permitted: insert a blanking module between two electronic devices.
- It should be used in dry, dust-free places at a temperature between 0 °C and +35 °C.

Rotating electronic regulators with two-way switch, for universal loads

Dimmer with incorporated two-way switch that makes it possible to command the switching on and off of a second point (using the two-way switch), or a number of points (using intermediate switches). Switched on and off by pressing the knob; adjustment by turning it.

Reference standards: EN 60669-1; EN 60669-2-1



Control knob:
 • ON/OFF with touch
 • adjustment via rotation

Indicator light for localisation and presence of mains voltage

TECHNICAL DATA	
Product code	GW 10 566 - GW 12 566 - GW 14 566
Power supply voltage	230V ac - 50Hz
Adjustable load	
- Incandescent and halogen lamps	20-160W
- Halogen lamps (12Vac) with electronic transformers	40-160W
- LED lamps (12Vac) with electronic transformers	4-110W (Max 2 transf. - max 3 lamps for each transf.)
- Dimmable 230V LED lamps	4-160W (Max 10 lamps)
Dimensions	1 Chorus module

Typical use:

- Domestic sector for light source adjustment.
- In existing systems, the dimmer with two-way switch can be easily installed in place of a two-way switch, without modifying the original circuit.

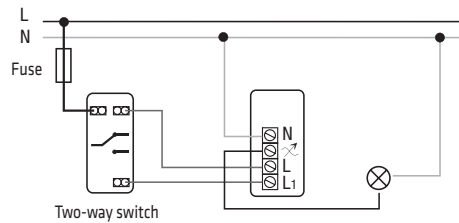
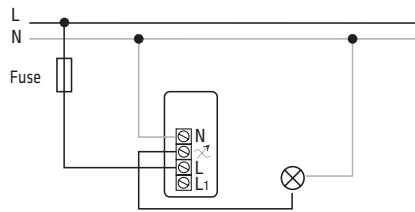

WARNINGS

- The connection should be made together with a fuse carrier (eg. GW1x491) with a quick-acting fuse with high breaking capacity type F1.6AH 250Vac as shown in the diagrams.
- The conductors should be pushed down to the bottom of the box. Do not let the conductors in the box contact the walls of the regulator.
- Do not install the regulator near thermostats or chronothermostats.
- Max n.1 regulator in the same round/square box. Max n.2 regulators in the same rectangular box; for installations with 2 regulators in the same box, the maximum loads controllable by each regulator should be reduced by 50%. The side-by-side installation of several products in a single box is not permitted: insert a blanking module between two electronic devices.
- It should be used in dry, dust-free places at a temperature between 0 °C and +35 °C.

Push-button electronic regulators, for universal loads

Double push-button type dimmer, with possibility of control and adjustment from any number of points using single-pole NO push-buttons; gradual switching on and off by briefly touching at the pre-set adjustment level (intensity memory); adjustment with prolonged pressure.

A dip-switch located on the side of the devices allows to set the type of driving of the dimmable lamps (Leading Edge or Trailing Edge mode) and the type of switching on (Flash-start or Soft-start).

Reference standards:
EN 60669-1; EN 60669-2-1

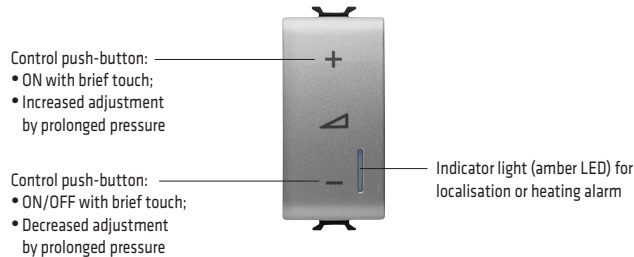

TECHNICAL DATA		
Product code	GW 10 572 A - GW 12 572 A - GW 14 572 A	GW 10 573 A - GW 12 573 A - GW 14 573 A
Power supply voltage	230V ac - 50/60Hz	230V ac - 50/60Hz
Adjustable load		
- Incandescent and halogen lamps	40-300W	40-300W
- Toroidal and lamellar transformers	40-300W	40-300W
- Electronic transformers	40-300W	40-300W
- Dimmable 230V LED lamps	5-150W (max. 10 lamps)	5-150W (max. 10 lamps)
Dimensions	1 Chorus module	2 Chorus modules

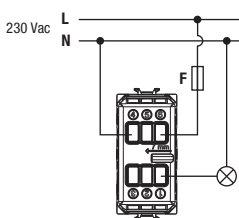

1-point light control

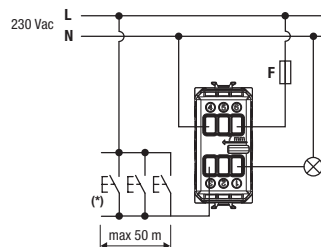

Multi-point light control with NO buttons

Notes:

(*) Illuminated push-buttons cannot be used with a built-in lamp for remote control

WARNINGS

- The connection should be made together with a fuse carrier (eg. GW1x491) with a quick-acting fuse with high breaking capacity type F2AH 250Vac as shown in the diagrams.
- The conductors should be pushed down to the bottom of the box. Do not let the conductors in the box contact the walls of the regulator.
- Do not install the regulator near thermostats or chronothermostats.
- Max n.1 regulator in the same round/square box. Max n.2 regulators in the same rectangular box; for installations with 2 regulators in the same box, the maximum loads controllable by each regulator should be reduced by 50%. The side-by-side installation of several products in a single box is not permitted: insert a blanking module between two electronic devices.
- The regulator does not have a mechanical circuit breaker in the main circuit and so is not galvanically separated. The circuit load should be considered always under voltage.
- It should be used in dry, dust-free places at a temperature between 0 °C and +35 °C.

Push-button electronic regulator, for resistive/inductive loads

Push-button type dimmer, with possibility of control and adjustment from any number of points using single-pole NO push-buttons; gradual switching on and off by briefly touching at the pre-set adjustment level (intensity memory); adjustment with prolonged pressure on the same button.

Reference standards: EN 60669-1; EN 60669-2-1

Control push-button:
- ON/OFF with touch;
- adjustment by prolonged pressure

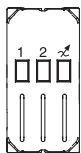
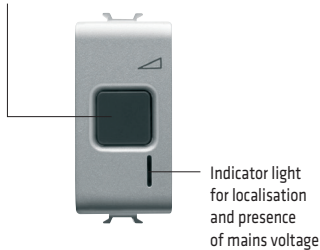

GW 10 568
GW 12 568
GW 14 568

Wiring terminals

Power supply: 2 - Phase
Command: ⚡ - Load
Input: 1 - Remote command

TECHNICAL DATA	
Product code	GW 10 568 - GW 12 568 - GW 14 568
Technology	with TRIAC
Power supply voltage	230V ac
Max. power of resistive load	60 - 500W
Max. power of inductive load	60 - 500VA
Adjustable load	
- Incandescent and halogen lamps	•
- Ferromagnetic transformers	•
Dimensions	1 Chorus module

CHARACTERISTICS	ADVANTAGES
Memorisation of adjustment level	Easy to position at a standard adjustment level
Gradual switching on	Increased lamp lifespan, reducing filament stress during cold switch-on; also prevents disturbing glare effect
Gradual switching off	Guarantees the gradual passage from the maximum light condition to the switched-off status

Typical use:

- Domestic sector for light source adjustment.
- Commercial sector, hotel rooms, places for communities, conference halls, for adjustment of light sources.
- In existing systems, the dimmers can be easily installed by replacing the two-way switches, without modifying the original circuit.

Multi-point light control and setting with NO push-buttons

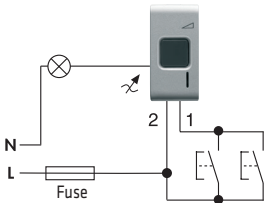

2-point light control (2 two-way switches)

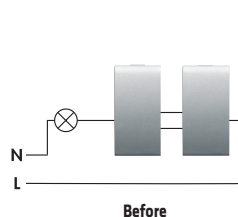

2-point light control and setting (1 regulator + 1 or more NO push-buttons)

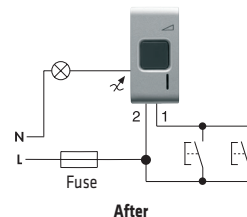

WARNINGS

- The connection should be made together with a fuse carrier (eg. GW1x491) with a quick-acting fuse with high breaking capacity type F2.5AH 250Vac as shown in the diagrams.
- The conductors should be pushed down to the bottom of the box. Do not let the conductors in the box contact the walls of the regulator.
- Do not install the regulator near thermostats or chronothermostats.
- Max n.1 regulator in the same round/square box. Max n.2 regulators in the same rectangular box; for installations with 2 regulators in the same box, the maximum loads controllable by each regulator should be reduced by 50%. The side-by-side installation of several products in a single box is not permitted: insert a blanking module between two electronic devices.
- The regulator does not have a mechanical circuit breaker in the main circuit and so is not galvanically separated. The circuit load should be considered always under voltage.
- It should be used in dry, dust-free places at a temperature between 0 °C and +35 °C.

Push-button electronic regulators, for air agitators

Push-button type dimmer with pre-set intensity levels (0-25-50-100%). By briefly pressing the push-button, the minimum intensity level will be obtained. With any further touch, the speed will change from the minimum to the medium, then the maximum. A subsequent touch will turn the dimmer off.

Reference standards: EN 60669-1; EN 60669-2-1

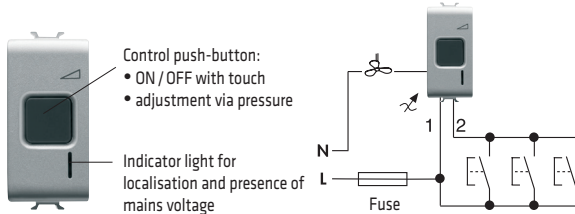

WARNINGS

- Article only suitable for adjusting air stirrers, fans and aspirators with induction motors with auxiliary phase. Not suitable for adjusting fan-coil motors or light sources.
- The connection should be made together with a fuse carrier (eg. GW1x491) with a quick-acting fuse with high breaking capacity type F0.8AH 250Vac as shown in the diagrams.
- The regulator does not have a mechanical circuit breaker in the main circuit and so is not galvanically separated. The circuit load should be considered always under voltage.
- Do not install the regulator near thermostats or chronothermostats.
- It should be used in dry, dust-free places at a temperature between 0 °C and +35 °C.

TECHNICAL DATA	
Product code	GW 10 574 - GW 12 574 - GW 14 574
Power supply voltage	230V ac
Power	55-80 VA
Dimensions	1 Chorus module

Typical use:

- suitable for adjusting air agitators, fans and extractors with induction engines. It can be controlled by external NO push-button.

TOUCH COMMANDS

Introduction

The Touch command devices are an innovative range of modular devices for the electrical system: a line of high technological and design content that gives the electrical system a touch of furnishing and style.

The most highly distinctive design-based aspect of the Touch products is the "wall-level" feature.

The main characteristic of the technology lies in the "cap-sensitive" system for command acquisition: a light touch (or slight brushing) of the device produces a change of status of the output command (switch-on, switch-off or adjustment).

The range consists of a one-way switch (GW 1X 904) and a dimmer (GW 1X 905), that can be commanded both locally and from a distance, using the command duplicator (GW 1X 906) or generic NO push-buttons.

Touch one-way switch

The quick and/or prolonged touch (or brushing) activates or switches off the load: this action can also be carried out from NO remote push-buttons and Touch command duplicators. A simple programming allows you to configure acoustic signals (buzzer), luminous signals (double intensity blue led) and the output contact (latching or momentary).



GW 10 904
GW 12 904
GW 14 904

TECHNICAL DATA	
Product code	GW 10 904 - 12 904 - 14 904
Power supply voltage	230V ac - 50 Hz
Load	halogen and incandescent lamps: 500W energy savings lamps: 100W (max 4 lamps) uncompensated fluorescent lamps: 100W
Dimensions	1 Chorus module

NOTE: for all the load types not indicated in the table, use an auxiliary relay.

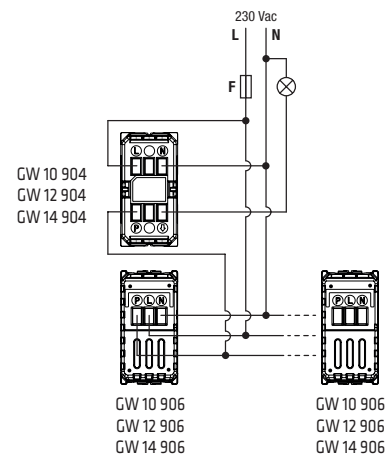

Connection terminals:

Power supply: N - Neutral
L - Phase
Command: - Load
Input: P - Remote command

WARNINGS

- The connection should be made together with a fuse carrier (eg. GW1x491) with a quick-acting fuse with high breaking capacity type F2.5AH 250Vac as shown in the diagrams.

For technical information contact the Technical Assistance Service or visit gewiss.com

Touch dimmer

The quick touch (or brushing) produces switch-off or load command at the pre-set (memory) value.

The prolonged touch (or brushing) produces load adjustment; this action can also be carried out from remote NO push-buttons and the Touch command duplicator. A simple programming allows you to configure acoustic signals (buzzer) and luminous signals (double intensity blue led).



GW 10 905
GW 12 905
GW 14 905

TECHNICAL DATA	
Product code	GW 10 905 - 12 905 - 14 905
Power supply voltage	230V ac
Power load	40 - 300VA
Adjustable load	Incandescent and halogen lamps toroidal and lamellar transformers
Dimensions	1 Chorus module

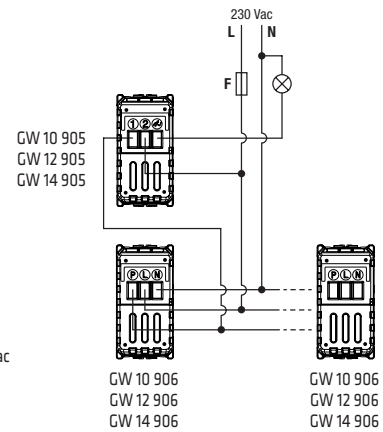

Connection terminals

Power supply: 2 - Phase
Command: \surd - Load
Input: 1 - Remote command

WARNINGS

- The connection should be made together with a fuse carrier (eg. GW1x491) with a quick-acting fuse with high breaking capacity type F2AH 250Vac as shown in the diagrams.
- The conductors should be pushed down to the bottom of the box. Do not let the conductors in the box contact the walls of the regulator.
- Do not install the regulator near thermostats or chronothermostats.
- Max n.1 regulator in the same round/square box. Max n.2 regulators in the same rectangular box; for installations with 2 regulators in the same box, the maximum loads controllable by each regulator should be reduced by 50%. The side-by-side installation of several products in a single box is not permitted: insert a blanking module between two electronic devices.
- The regulator does not have a mechanical circuit breaker in the main circuit and so is not galvanically separated. The circuit load should be considered always under voltage.
- It should be used in dry, dust-free places at a temperature between 0 °C and +35 °C.

Touch command duplicator

The Touch command duplicator can only work with the Touch one-way switches and dimmers.

The command duplicators connected to the Touch products behave as NO push-buttons, with the distinctive feature of maintaining the technical and design characteristics of the system unaltered. The quick and/or prolonged touch (or brushing) produces the cyclical activation of the load (by means of a Touch dimmer or one-way switch). In standby conditions, the front LED is fixed amber. A simple programming allows you to configure acoustic signals (buzzer) and luminous signals (double intensity blue led). It is not possible to understand the load status from the command duplicator.



GW 10 906
GW 12 906
GW 14 906

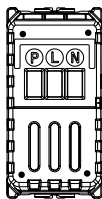

Connection terminals

Power supply: N - Neutral
L - Phase
Output: P - Remote command

TECHNICAL DATA	
Product code	GW 10 906 - 12 906 - 14 906
Power supply voltage	230V ac
Dimensions	1 Chorus module

WARNINGS

- The connection should be made together with a fuse carrier (eg. GW1x491) with a quick-acting fuse with high breaking capacity type F.

TOUCH COMMAND MODULES

Introduction

The Touch command devices are an innovative range of modular devices for the electrical system: a line of high technological and design content that gives the electrical system a touch of furnishing and style, thanks to the ICE Touch plates made in glass.

The main characteristic of the technology lies in the "cap-sensitive" system for command acquisition: a light touch (or slight brushing) of the device produces a change of status of the output command (switch-on, switch-off or adjustment).

The range consists of a one-way switch module (GW 10 907) and a dimmer module (GW 10 908) that can be commanded both locally and from a distance, using the command duplicator module (GW 10 909) or generic NO push-buttons.

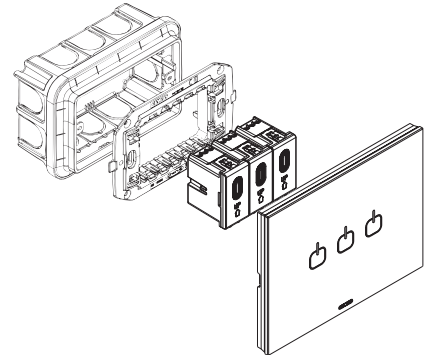

Touch one-way switch module

The quick and/or prolonged touch (or brushing) activates or switches off the load: this action can also be carried out from NO remote push-buttons and Touch command duplicator modules. A simple programming allows you to configure acoustic signals (buzzer), luminous signals (double intensity blue led) and the output contact (latching or momentary).

To be completed with italian standard ICE Touch glass plate, with 1, 2 or 3 symbols, in white colour (GW 16 951 CB, GW 16 952 CB or GW 16 953 CB), black colour (GW 16 951 CN, GW 16 952 CN or GW 16 953 CN) or titanium colour (GW 16 951 CT, GW 16 952 CT or GW 16 953 CT).



GW 10 907

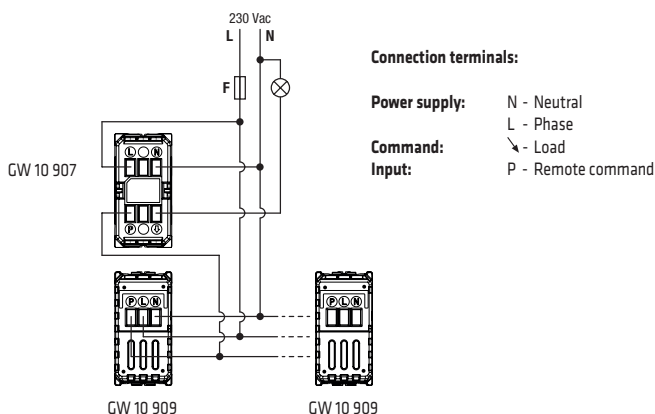

TECHNICAL DATA	
Product code	GW 10 907
Power supply voltage	230V ac - 50 Hz
Output contact	NO relay (with potential 230Vac)
Load	halogen and incandescent lamps: 500W energy savings lamps: 100W (max 4 lamps) uncompensated fluorescent lamps: 100W
Dimensions	1 Chorus module

NOTE: for all the load types not indicated in the table, use an auxiliary relay.

WARNINGS

- The product must be protected by a F2.5AH 250Vac fuse with high breaking capacity, positioned on the power supply line.

Touch dimmer module

The quick touch (or brushing) produces switch-off or load command at the pre-set (memory) value. The prolonged touch (or brushing) produces load adjustment; this action can also be carried out from NO remote push-buttons and Touch command duplicator modules. A simple programming allows you to configure acoustic signals (buzzer) and luminous signals (double intensity blue led).

To be completed with italian standard ICE Touch glass plate, with 1, 2 or 3 symbols, in white colour (GW 16 951 CB, GW 16 952 CB or GW 16 953 CB), black colour (GW 16 951 CN, GW 16 952 CN or GW 16 953 CN) or titanium colour (GW 16 951 CT, GW 16 952 CT or GW 16 953 CT).



GW 10 908

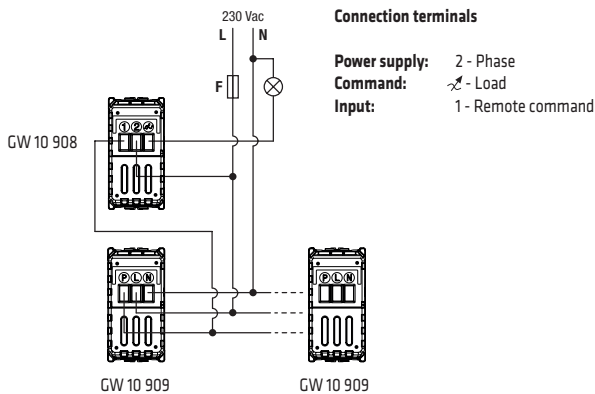

Connection terminals

Power supply: 2 - Phase
Command: ⚡ - Load
Input: 1 - Remote command

TECHNICAL DATA	
Product code	GW 10 908
Power supply voltage	230V ac
Power load	40 - 300VA
Adjustable load	Incandescent and halogen lamps
	Toroidal and lamellar transformers
Dimensions	1 Chorus module

WARNINGS

- The connection should be made with a quick-acting fuse with high breaking capacity type F2AH 250Vac as shown in the diagrams.
- The conductors should be pushed down to the bottom of the box. Do not let the conductors in the box contact the walls of the regulator.
- Max n.2 regulators in the same rectangular box; for installations with 2 regulators in the same box, the maximum loads controllable by each regulator should be reduced by 50%.
- Leave the space of one module between two dimmer modules to avoid overheating.
- The regulator does not have a mechanical circuit breaker in the main circuit and so is not galvanically separated. The circuit load should be considered always under voltage.
- It should be used in dry, dust-free places at a temperature between 0 °C and +35 °C.

Touch command duplicator module

The Touch command duplicator module can only work with the Touch one-way switch and dimmer modules.

The command duplicator modules connected to the Touch products behave as NO push-buttons, with the distinctive feature of maintaining the technical and design characteristics of the system unaltered. The quick and/or prolonged touch (or brushing) produces the cyclical activation of the load (by means of a Touch dimmer or one-way switch modules). A simple programming allows you to configure acoustic signals (buzzer) and luminous signals (double intensity blue led). It is not possible to understand the load status from the command duplicator.

To be completed with italian standard ICE Touch glass plate, with 1, 2 or 3 symbols, in white colour (GW 16 951 CB, GW 16 952 CB or GW 16 953 CB), black colour (GW 16 951 CN, GW 16 952 CN or GW 16 953 CN) or titanium colour (GW 16 951 CT, GW 16 952 CT or GW 16 953 CT).



GW 10 909

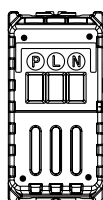

Connection terminals:

Power supply: N - Neutral
 L - Phase
Output: P - Remote command

TECHNICAL DATA	
Product code	GW 10 909
Power supply voltage	230V ac
Dimensions	1 Chorus module

WARNINGS

- The product must be protected by a F fuse with high breaking capacity, positioned on the power supply line.

ELECTRONIC PUSH-BUTTONS

Introduction

The electronic push-buttons are an innovative range of modular devices, characterised by their minimum stroke and light, silent activation. Suitable for both conventional and domestic electric systems. The range includes a illuminated 230V AC push-button (GW 1X 912), a illuminated push-button for BUS inputs (GW 1X 913), a double arrow push-button (GW 1X 914) and a universal push-button (GW 1X 915).

Backlit electronic push-button

The generic push-button for 230V AC applications is specifically designed to command bistable relays, electronic one-way switches for heavy loads, or dimmers with a remote control input. Equipped with amber localisation LED.



GW 10 912
GW 12 912
GW 14 912

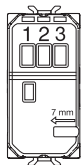

Wiring terminals

Power supply: 1 - Neutral
3 - Phase

Command: 2 - Load

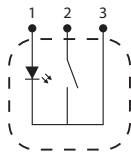

TECHNICAL DATA	
Product code	GW 10 912 - GW 12 912 - GW 14 912
Power supply voltage	230V AC
Type of contact	4A (AC1) - 230V ac
Type of load	Relay dimmer (with remote control input)
LED	localisation (amber)
Dimensions	1 Chorus module

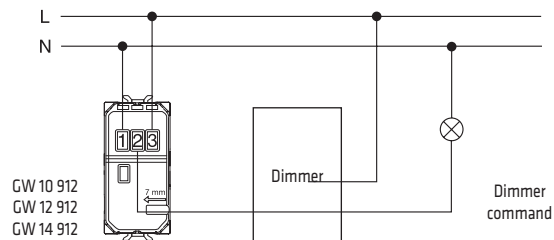
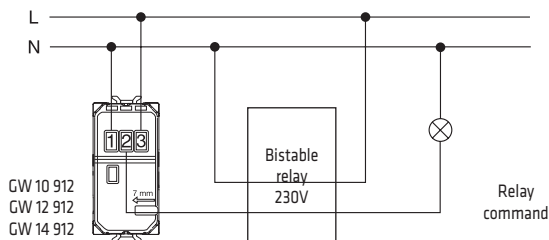

Backlit push-button for BUS inputs

The push-button for BUS inputs is designed for KNX BUS contact interface connections. Equipped with two-colour LED (for night-time localisation or load status signalling).



GW 10 913
GW 12 913
GW 14 913

Connection of 1 channel of a KNX BUS contact interface



Channel 1



GW 10 913
GW 12 913
GW 14 913

Wiring terminals

Command: 1 - LED
3 - Common
2 - Contact

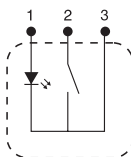

TECHNICAL DATA	
Product code	GW 10 913 - GW 12 913 - GW 14 913
Type of contact	Potential-free
Type of load	BUS contact interfaces
LED	Two-colour: amber/green - the colour can be chosen using the selector. Can be programmed to act as a night-time localisation indicator light, or to show the load status
Dimensions	1 Chorus module

Double electronic push-button

The double push-button for roller shutters is designed for the connection of KNX BUS contact interfaces, or electronic control panels for moving the roller shutters.



GW 10 914
GW 12 914
GW 14 914

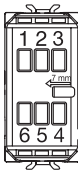

Wiring terminals

- UP arrow:**
- 1 - NO contact
 - 2 - NC contact
 - 3 - Common
- DOWN arrow:**
- 4 - NO contact
 - 5 - NC contact
 - 6 - Common

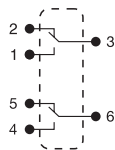

TECHNICAL DATA	
Product code	GW 10 914 - GW 12 914 - GW 14 914
Type of contact	Double potential-free contact with interlock
Type of load	BUS contact interfaces Electronic control units for roller shutters
Dimensions	1 Chorus module

Connection of 2 channels of a KNX BUS contact interface

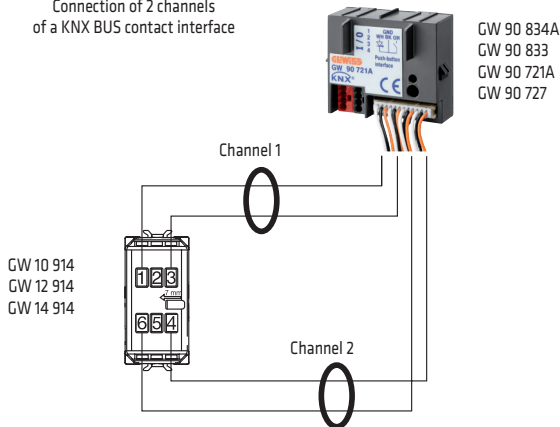

Connection to electronic control panel for moving roller shutters

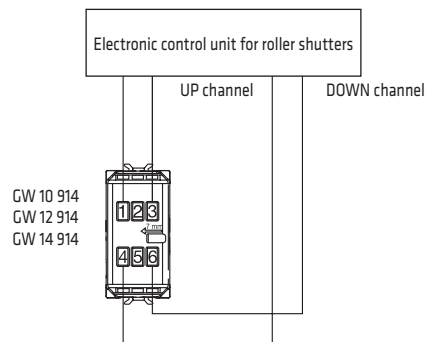

Universal electronic push-button

The push-button is suitable for KNX BUS contact interface connections or the command of bistable relays, electronic one-way switches for heavy duty loads or dimmers with a remote control input.



GW 10 915
GW 12 915
GW 14 915

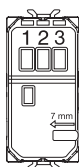

Wiring terminals

- 1 - NO contact
- 2 - NC contact
- 3 - Phase

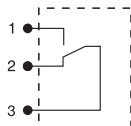

TECHNICAL DATA	
Product code	GW 10 915 - GW 12 915 - GW 14 915
Type of contact	4A (AC1) - 230V ac
Type of contact	Potential-free
Type of load	Relay Dimmer (with remote control input) Bus contact interfaces
Dimensions	1 Chorus module

CLIMATE CONTROL

Timed thermostat - daily/weekly programming

The timed thermostat allows you to automatically control the weekly temperature and timing within the place of installation, together with the heating and air-conditioning systems.

- Powered by mains voltage
- Relay output contact for commanding the boiler, air-conditioner, zone solenoid valve, etc.
- LCD display with white backlight (the backlighting is activated every time one of the button-keys is pressed, and switches off 5 seconds after the last touch)
- Programming on a weekly basis (a programme for 7 days with hourly profiles independently configurable for each day)
- Setting of hourly profile on 24-hour basis, with 3 different temperature levels (T1, T2, T3) and profile display
- Programming of times with a resolution of 15 minutes without a limit in the number of daily changes
- Residual current circuit breaker for adjustment can be set and differentiated for HEATING and AIR-CONDITIONING
- PARTY and HOLIDAY functions for programming special functioning speeds of different duration periods
- Functioning modes that can be set: AUTOMATIC / MANUAL / OFF
- Possibility to select the system thermal gradient self-learning function. This function optimises the heating anticipation (up to 2 hours) in order to guarantee the set temperature right from program start;
- Rechargeable buffer battery.

Reference standards:
EN 60730-1; EN 60730-2-7, EN 60730-2-9

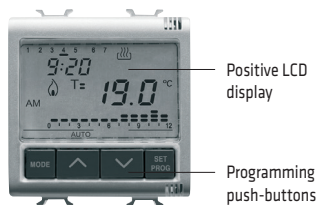

GW 10 703 - GW 12 703 - GW 14 703

TECHNICAL DATA	
Power supply voltage	230V AC 50/60Hz
Dimensions	2 modules
Output contact	1NO/NC with potential-free contact 5A(AC1) / 2A(AC15) 250V AC
Operating temperature	-5 to +45°C
Detected temperature display range	0 to +45°C
Adjustment range	+5 to +40°C
Tolerance	±0.5°C to 20°C
Reserve charge	48 hours

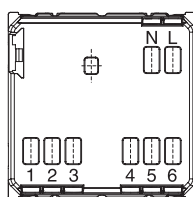

Wiring terminals

- Power supply:** L - Phase
N - Neutral
- Output relay:** 1 - NO contact
2 - NC contact
3 - Common
- Serial line:** 4 - TX
5 - GND (common)
6 - RX

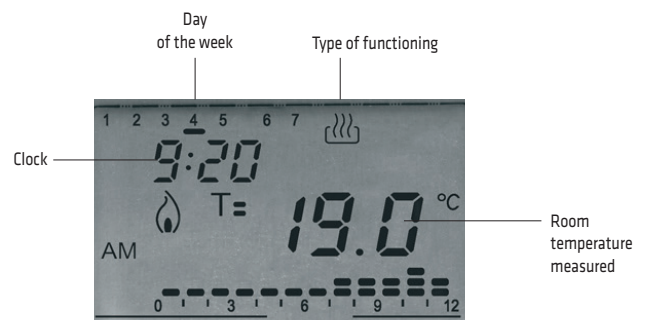

Wall-mounting timed thermostat - daily/weekly programming - battery-powered

The timed thermostat allows you to automatically control the weekly temperature and timing within the place of installation, together with the heating and air-conditioning systems.

- Powered with 3 alkaline batteries (1.5V AAA)
- Relay output contact for commanding the boiler, air-conditioner, zone solenoid valve, etc.
- Programming on a weekly basis (a programme with hourly profiles independently configurable for each day of the week)
- Setting of hourly profile on 24-hour basis, with 3 different temperature levels (T1, T2, T3) and profile display
- Programming of times with a resolution of 15 minutes without a limit in the number of daily changes
- Residual current circuit breaker for adjustment can be set and differentiated for HEATING and AIR-CONDITIONING
- PARTY and HOLIDAY functions for programming special functioning speeds of different duration periods
- Functioning modes that can be set: AUTOMATIC / MANUAL / OFF
- Possibility to select the system thermal gradient self-learning function. This function optimises the heating anticipation (up to 2 hours) in order to guarantee the set temperature right from program start;

The device can be surface-mounted (fixed with plugs) or installed on a 3-module flush-mounting box.

Reference standards: EN 60730-1; EN 60730-2-7, EN 60730-2-9



GW 10 701 - GW 14 701

TECHNICAL DATA	
Power supply	3 alkaline-type batteries (1.5V AAA)
Average battery life:	minimum 1 year
Dimensions	130 x 92 x 23mm
Output contact	1NO/NC with potential-free contact 5A(AC1) / 2A(AC15) 250V AC
Operating temperature	-5 to +45°C
Detected temperature display range	0 to +45°C
Adjustment range	+5 to +40°C
Tolerance	± 0.5°C to 20°C

Base for fixing on wall with terminal block

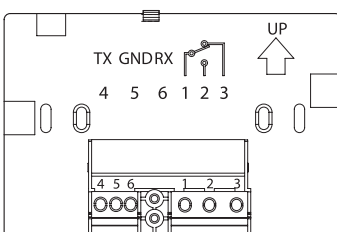

Wiring terminals

Potential-free output:

- 1 - Common
- 2 - NO contact
- 3 - NC contact

Serial line:

- 4 - TX
- 5 - GND (common)
- 6 - RX

For technical information contact the Technical Assistance Service or visit gewiss.com

Thermo ICE WiFi thermostats with plate in glass - for flush-mounting

The thermostats manage the temperature of the room where they are installed. The temperature is regulated by commanding the solenoid valve or the heating/cooling system with a two-way logic, via the local relay.

The thermostats, realized with a glass surface, are equipped with a white LED backlit display, touch commands, circular touch slider, RGB signalling LED and include a sensor for measuring the room temperature and a proximity sensor for activating the back-lighting when the user approaches it.

- 2 types of operation: heating and cooling with independent control algorithms;
- 2 types of control: HVAC or Setpoint;
- 4 HVAC operating modes: OFF (anti-freeze / high temperature protection), Economy, Precomfort and Comfort, with a specific parameter for regulating the temperature for each mode;
- control algorithms for 2-way systems: two ON/OFF points or PI proportional with PWM control;
- 1 relay output with NO/NC contact;
- 1 input for a potential-free contact for the window contact function;
- 1 input for temperature NTC external sensor (e.g: protection sensor for underfloor heating).

The thermostats Thermo ICE WiFi have a built-in WiFi interface for the connection to domestic WLAN/internet and the management via APP. Thanks to the «THERMO ICE» APP, it is possible to control the thermostat and display its operating state, set the parameters, define the temperature profiles (timed thermostat function), enable the self-learning function for the daily profiles.

The «Thermo ICE» APP is available for smartphone and tablet running iOS and Android operating systems and requires a Cloud connection to reach the thermostat.

Reference standards: EN 60730-2-9



GW 16 972 CB - GW 16 972 CT - GW 16 972 CN

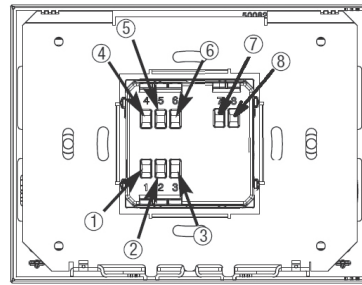
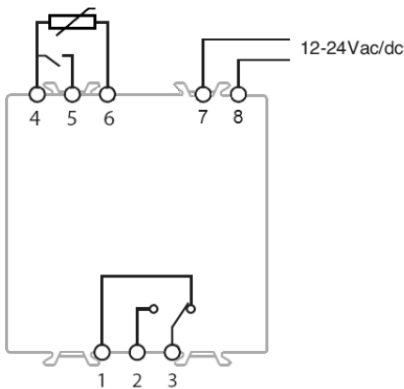

- 1 - NC output
- 2 - NO output
- 3 - Common wire for outputs
- 4 - Common wire for inputs
- 5 - Auxiliary input for potential-free contact
- 6 - Input for temperature external sensor
- 7 - Power supply 12-24Vac/dc
- 8 - Power supply 12-24Vac/dc

TECHNICAL DATA	
Power supply	12-24Vac/dc Consumption max. 4.5W (@12-24Vac) - max. 3.6W (@12-24Vdc)
Power consumption	max. 2W (Thermo ICE) - 6W (Thermo ICE WIFI)
Inputs	1 input for a potential-free contact for the window contact function (cable length max. 10m) 1 input for temperature external sensor (es: GW 10 800), type NTC 10K
Outputs	1 NO/NC with potential-free contact 5A (cosφ=1) 250Vac
Temperature adjustment range	+5 ÷ +40°C
Dimension of glass plate (BxHxP)	123x95x11 mm
Mounting	In 3-gang rectangular, square or round flush-mounting boxes
Fixing support	In metal (included)
WiFi connection	2.4 GHz IEEE 802.11 b/g/n

Thermostat

The flush-mounting thermostat commanding a boiler and/or an air-conditioner regulates the temperature in an easy, efficient way.

The choice of temperature is made by simply rotating the knob and positioning it on the value you want.

The frontal selector allows you to select 3 different functioning modes.

- SUMMER (air-conditioner) - the output will be active when the temperature recorded by the thermostat is greater than the value indicated by the knob.
- WINTER (boiler) - the relay output will be active when the temperature recorded by the thermostat is lower than the value indicated by the knob. In winter mode, the antifreeze function is active (pre-set at +5°C).
- OFF - the output is never activated.

Reference standards: EN 60730-1; EN 60730-2-9

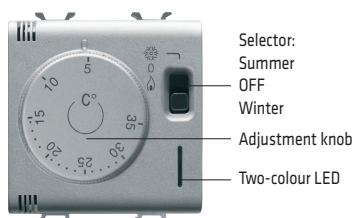

GW 10 705 - GW 12 705 - GW 14 705

TECHNICAL DATA	
Power supply voltage	230V AC
Power absorbed	2 VA
Adjustment range	+5 to +35°C
Hysteresis	1°C
Output contact	1NO/NC 8A(AC1) 250V AC

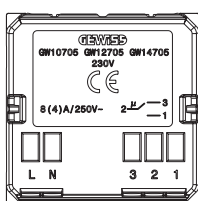

Connection terminals

Power supply: L - Phase
N - Neutral

Output relay: 1 - NO contact
2 - Common
3 - NC contact

The thermostat is fitted with two LEDs; the yellow light has a localisation function, while the green one indicates the activation of the output.

SAFETY

Gas detectors

The gas detectors reveal the presence of substances (CH₄/GPL) that are dangerous for the domestic environment where they are installed

- Indicator lights and acoustic alarm signalling
- Closure of a solenoid valve, via relay
- Indicator lights for malfunctioning of sensor or device
- Device operating test function

The closure of the solenoid valve via the relay is carried out approximately 20s after the start of the alarm situation.

The push-button allows you to carry out the operational test: when pressed, the red LED lights up (alarm signalling), the buzzer sounds and, after about 20s, the relay is activated. Upon the release of the push-button, the signalling is immediately deactivated.

The detectors can be powered through the 12V power supply unit GW10720.

Owing to the particular thermal sensitivity of the LPG sensor, you are advised to position it far from the power supply unit, and apply a blanking module.

Reference standards: CEI 216-8

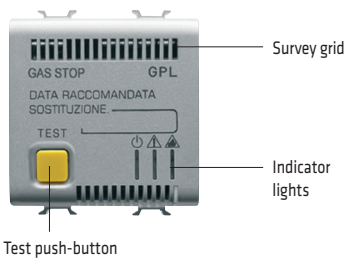

LPG
GW 10 711 - GW 12 711 - GW 14 711
METHANE GAS
GW 10 712 - GW 12 712 - GW 14 712

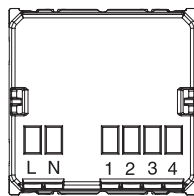

Connection terminals

L-N - 12V AC/DC power supply
1 - Common
2 - NC contact
3 - NO contact
4 - NO contact

TECHNICAL DATA	
Power supply voltage	12V AC/DC
Power absorbed	2 VA
Alarm threshold	9% LIE (lower explosive limit)
Alarm sound level	85 dB at 1m
Operating temperature	+5 to +40°C
Relative environmental humidity	+30 to +90% without condensation
Output contact in switching:	1 NO/NC 10A (NO)/3A (NC) 250V AC
Fixing	flush-mounting on CHORUS support
Dimensions	2 modules
Lifespan of device	5 years from when first powered

Connection diagram

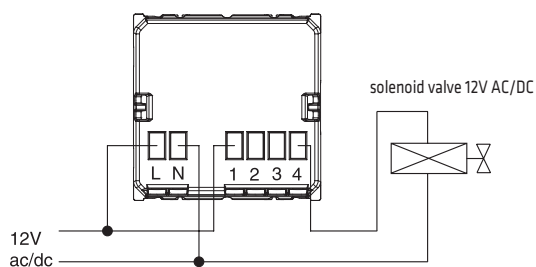

Correct positioning of detectors

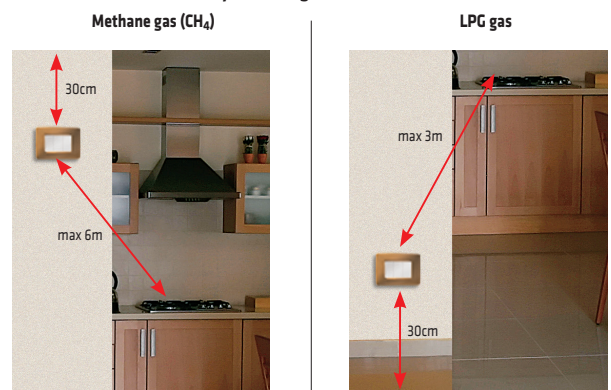

12V power supply unit

Insulation transformer suitable for the power supply of gas detectors (methane and LPG) and WiFi Thermo ICE thermostats. Internally protected against overloading, short-circuiting and excessively high temperatures.

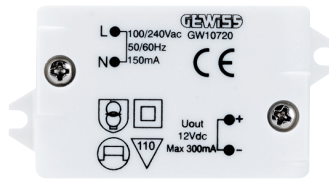

GW 10 720

Wiring terminals

Power supply:

L - Phase
N - Neutral

12V output:

+12V - Positive
-12V - Negative

TECHNICAL DATA

Power supply voltage	110/240Vac - 50/60Hz - 150mA
Output voltage	12V dc - 300mA
Dimensions (mm)	52x33x17

Anti-flood system with wireless sensor

The anti-flood system consists of one or more flood alarms (GWA1514) that reveal the presence of water and an actuator (GWA1521) for the control of the solenoid valve. The devices, that communicate via the Zigbee protocol in a wireless mode, need to be manually binded each other with a simple procedure using the programming buttons and the dip-switches.

The flood alarms can be freely positioned on the floor or can be wall mounted thanks to their specific accessories (GWA1541); the actuator can be easily located on the bottom of flush-mounted boxes, junction boxes or coupled to a specific Chorus blind module (GW1x750).

In the event of flooding, the flood alarms send luminous and acoustic signals and, through the actuator, they command the closure of the solenoid valve contact. The contact can only be reactivated locally, pressing a push-button wired to the actuator.

The flood alarms are battery operated: the necessity to replace the battery is reported by short acoustic and luminous notifications.

Reference standards: IEC 60669-2-1, EN 300 328, 2014/53/UE

Zigbee flood alarms



GW A1 514

TECHNICAL DATA	
Radio protocol	Zigbee / IEE 802.15.4
Frequency	2.4 GHz
Output power	+8 dBm
Power supply	CR123 replaceable
Siren	85 dB @3m
Degree of protection	IP20
Operating temperature	0 ÷ +50 °C
Dimensions	Ø 60 x 37mm
Certifications	Zigbee

Zigbee actuator

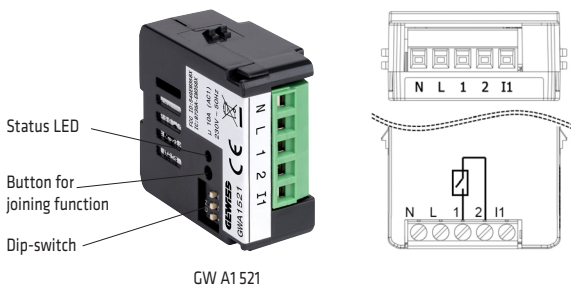

GW A1 521

TECHNICAL DATA	
Radio protocol	Zigbee / IEE 802.15.4
Frequency	2.4 GHz
Output power	+3 dBm
Power supply	230V ac - 50 Hz
Relay contact	10A NA - Potential-free
Terminal blocks	With screws - Section max 1,5mm ²
Degree of protection	IP20
Operating temperature	-5 ÷ +45 °C
Dimensions	42x40x20mm
Certifications	Zigbee

Installation characteristics

Connection diagram

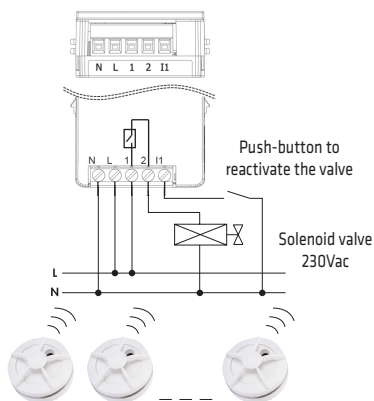

Water sensor accessory



Accessory for the wall mounting of the GWA1514 flood alarm.

For technical information contact the Technical Assistance Service or visit gewiss.com

HOTEL COMPONENTS

"Do not disturb" and "Make up the room" interchangeable button keys and light signalling

Interchangeable button keys with "Do not disturb" and "Make up the room" pad printings, to be used to customize the Chorus command devices (eg: switches, push-buttons, etc.) in the hotel rooms.

The indicator lamp unit, located outside the room, is used to inform the service staff about the customer's will not to be disturbed or to clean the room. The device can accept two LED signalling units, not included (eg: GW10881, GW10882, etc.).



Interchangeable button
DND
GW 10 731 - GW 12 731 - GW 14 731

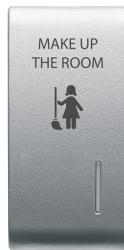

Interchangeable button
MUR
GW 10 732 - GW 12 732 - GW 14 732



Interchangeable button
DND + MUR
GW 10 733 - GW 12 733 - GW 14 733



Indicator lamp unit
DND + MUR
GW 10 736 - GW 12 736 - GW 14 736