



## LIGHT KIT MAIN ROUND 3MT



Product code	Colour
7501-30-30	Black
7501-30-31	White
7501-30-42	Satin silver

### General Specifications

Product type	: Tracks
Mounting type	: Ceiling - surface, Pendant
Description	: 3-phase tracks
Indoor/outdoor lights	: Indoor

### Physical Specifications

Load capacity (Kg)	: The track has a load capacity of 2Kg every 200mm, with a maximum distance of 800mm between the fixing points. For a 10Kg load every 200mm, a maximum fixing distance of 400 mm is recommended.
--------------------	--

### Electrical Specifications



Current (A)	: 16
Glow wire (°C)	: 850
Voltage (V)	: 230/440

### Weight and Dimensions

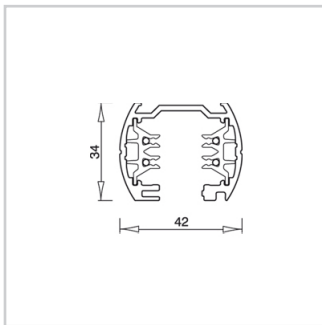
Shape	: Round
Length (mm)	: 3000
Width (mm)	: 42
Height (mm)	: 34

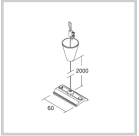
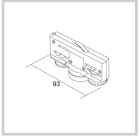
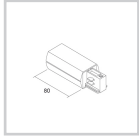
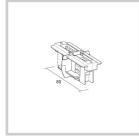
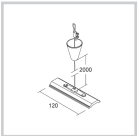

## Accessories

									
7606-00-30/31 Suspension kit	7600-00-20/30/31 Electro/mechanical adapter	7601-00-W20/30/31 Mechanical/electrical adapter	7602-10-W20/30/31 Right live-end	7602-11-W20/30/31 Left live-end	7605-10-W20/30/31 Inside L joint	7605-11-W20/30/31 Outside L joint	7622-10-W20/30/31 X joint	7619-10-W30/31 Mechanical straight joint	7624-00-30/31 Track cover
									
7606-05-30/31 Suspension kit	7606-04-00 Plate	7625-00-30/31/52 Mechanical adapter	7603-10-W20/30/31 Central connector and straight joint	7621-10-W20/30/31 Right T joint	7621-11-W20/30/31 Left T joint	7610-10-W20/30/31 Flexible joint	7623-00-W20/30/31 Dead end	7607-00-00 Ceiling kit	7626-00-00 Suspension kit
									
7618-00-30/31/52 Mechanical adapter with automatic locking									

## Pictures and Applications

