

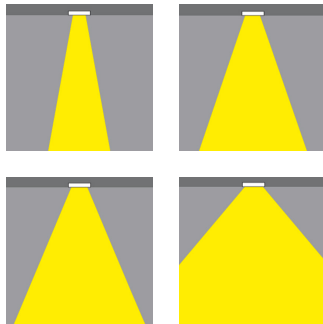
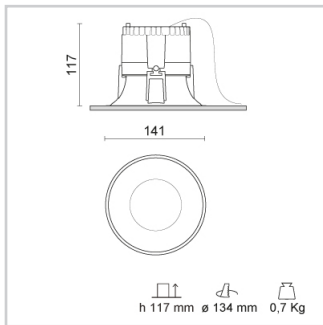

RA 11 SOFT DIXIT LED 3000K
Design: Studio Tecnico Ivela

Product code	Color
258-200BN-21	Mat white

General Specifications

Product type	: Downlights
Mounting type	: Ceiling - recessed
Description	: Fixed downlight for diffused lighting, designed for the last generation of COB LEDs. LED drivers should be ordered separately, the wattage of the fittings changes depending on the selected driver. Protection rating IP43. Low glare levels UGR < 19
Indoor/outdoor lights	: Indoor
Applications	: Offices, Retail , Shopping centres

Lighting specifications

Average lamp life (h)	: L80B10 50.000
Lamp description	: LED 1700lm 12W 3000K
Nominal lumens on thermal regime	: 1700
Efficiency L.O.R. (%)	: 89
Delivered lumens (lm)	: 1513
Lamp wattage (W)	: 12
Color temperature (K)	: 3000

Physical Specifications

Body	: Die-cast aluminium
Finishes	: Polyester painted
Reflector	: Mirror-metallized thermoplastic material
Closing Screen	: Clear polycarbonate
Thermal Dissipation	: Passive

Electrical Specifications

Glow wire (°C)	: 850
Driver	: Separate item
Driver mounting	: Remote

Weight and Dimensions

Shape	: Round
External diameter (mm)	: 141
False ceiling thickness (mm)	: 1-30
Height (mm)	: 117
Cutout shape	: Round
Cutout Diameter (mm)	: 134
Recessed depth (mm)	: 117
Weight (Kg)	: 0.7

Optical Specifications

Aiming	: Fixed
Light distribution	: Symmetric
Light emission	: Direct
Light beam	: 55°
Note	: 12°, 30° (mirror metallized), 70° (white) optics and honeycomb are available on demand.
Unified Glare Rating (U.G.R.)	: <19

ACCESSORIES



Product Code : 28-3142-51
 Name : Professional optic device 30°
 Finish : Mirror metallized
 Shape : Round



Product Code : 28-3141-31
 Name : Professional optic device 70°
 Finish : White
 Shape : Round

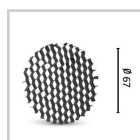

Product Code : 28-4019-30
 Name : Honeycomb
 Finish : Black painted
 Shape : Round



Product Code : 28-3140-51
 Name : Professional optic device 12° (included diffuser)
 Finish : Mirror metallized
 Shape : Round

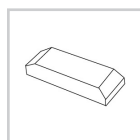

Drivers



Product Code : 81-04010
 Name : Driver 350mA dimmable on the mains

Lamps	Lamp categories	Lamp type	Lamp wattage (W)	Nominal lumens on thermal regime (lm)	Color temperature (K)	Color rendering (CRI)
	LED	COB LED	12	1700	3000	85

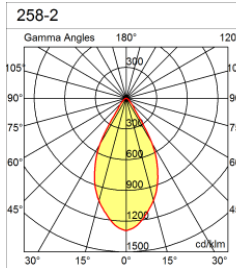
Photometrics

258-2 Gamma Angles 180° 120° 90° 75° 60° 45° 30° 15° 0° 15° 30° 3000 600 900 1200 1500 cd/m ²	RA 11 DIXIT LED SOFT 12W 1700 lm 3000K				Alpha=54°	R:100%				Beta=54°	I.Max:1293 Cd/Klm			
	H[m]	D[m]	Max lux	Med lux		H[m]	D[m]	Max lux	Med lux		H[m]	D[m]	Max lux	Med lux
	1.00	1.02	1913	1003		1.00	1.02	1913	1003		1.00	1.02	1913	1003
	2.00	2.04	478	251		2.00	2.04	478	251		2.00	2.04	478	251
	3.00	3.06	213	111		3.00	3.06	213	111		3.00	3.06	213	111
	4.00	4.08	120	63		4.00	4.08	120	63		4.00	4.08	120	63
	5.00	5.10	77	40		5.00	5.10	77	40		5.00	5.10	77	40

Pictures and Applications

