

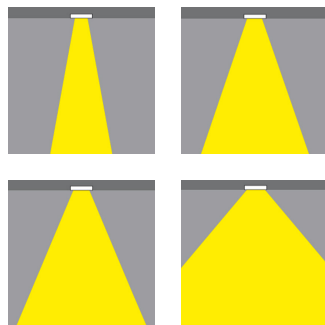
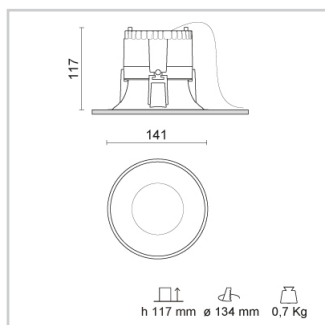

RA 11 SOFT DIXIT LED 3000K
Design: Studio Tecnico Ivela

Product code	Color
258-200BN-21	Mat white

General Specifications

Product type	: Downlights
Mounting type	: Ceiling - recessed
Description	: Fixed downlight for diffused lighting, designed for the last generation of COB LEDs. LED drivers should be ordered separately, the wattage of the fittings changes depending on the selected driver. Protection rating IP43. Low glare levels UGR < 19
Indoor/outdoor lights	: Indoor
Applications	: Offices, Retail , Shopping centres

Lighting specifications

Average lamp life (h)	: L80B10 50.000
Lamp description	: LED 2350lm 18W 3000K
Nominal lumens on thermal regime	: 2350
Efficiency L.O.R. (%)	: 89
Delivered lumens (lm)	: 2092
Lamp wattage (W)	: 18
Color temperature (K)	: 3000

Physical Specifications

Body	: Die-cast aluminium
Finishes	: Polyester painted
Reflector	: Mirror-metallized thermoplastic material
Closing Screen	: Clear polycarbonate
Thermal Dissipation	: Passive

Electrical Specifications

Glow wire (°C)	: 850
Driver	: Separate item
Driver mounting	: Remote

Weight and Dimensions

Shape	: Round
External diameter (mm)	: 141
False ceiling thickness (mm)	: 1-30
Height (mm)	: 117
Cutout shape	: Round
Cutout Diameter (mm)	: 134
Recessed depth (mm)	: 117
Weight (Kg)	: 0.7

Optical Specifications

Aiming	: Fixed
Light distribution	: Symmetric
Light emission	: Direct
Light beam	: 55°
Note	: 12°, 30° (mirror metallized), 70° (white) optics and honeycomb are available on demand.
Unified Glare Rating (U.G.R.)	: <19

ACCESSORIES



Product Code : 28-3142-51
 Name : Professional optic device 30°
 Finish : Mirror metallized
 Shape : Round



Product Code : 28-3141-31
 Name : Professional optic device 70°
 Finish : White
 Shape : Round

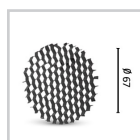

Product Code : 28-4019-30
 Name : Honeycomb
 Finish : Black painted
 Shape : Round



Product Code : 28-3140-51
 Name : Professional optic device 12° (included diffuser)
 Finish : Mirror metallized
 Shape : Round

Drivers

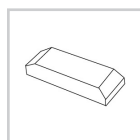

Product Code : 81-04011
 Name : Driver 500mA

Lamps	Lamp categories	Lamp type	Lamp wattage (W)	Nominal lumens on thermal regime (lm)	Color rendering (CRI)
	LED	COB LED	18	2350	85

Photometrics

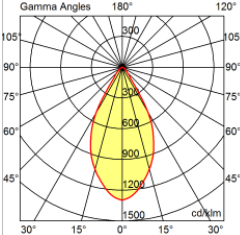
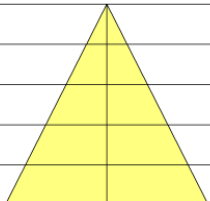
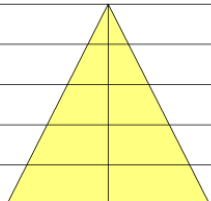
258-2	RA 11 DIXIT LED SOFT 18W 2350 lm 3000K				R:100%	I.Max:1299 Cd/Klm				
Gamma Angles	H[m]	D[m]	Max lux	Med lux	Alpha=53°	H[m]	D[m]	Max lux	Med lux	Beta=53°
	1.00	1.02	2610	1368		1.00	1.02	2610	1368	
	2.00	2.03	653	342		2.00	2.03	653	342	
	3.00	3.05	290	152		3.00	3.05	290	152	
	4.00	4.07	163	85		4.00	4.07	163	85	
	5.00	5.08	104	55		5.00	5.08	104	55	

Pictures and Applications

