

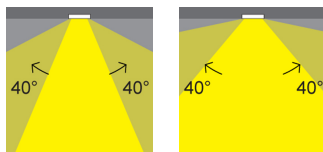
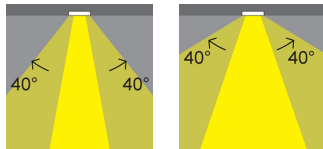
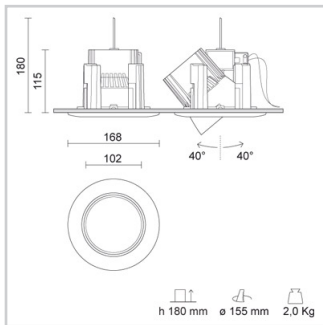

RA 17 DIXIT LED ADJUSTABLE 36W 3000K
Design: Studio Tecnico Ivela

Product code	Color
248-240BN-21	Mat white

General Specifications

Product type	: Downlights
Mounting type	: Ceiling - recessed
Description	: Adjustable downlight, designed for the last generation of COB LEDs. It grants a perfect control of the light beam and an excellent colour rendering. LED drivers should be ordered separately, the wattage of the fitting changes depending on the selected driver. Optics for different beams are also available..
Indoor/outdoor lights	: Indoor
Applications	: Retail ,Shopping centres

Lighting specifications

Average lamp life (h)	: L80B10 50.000
Lamp description	: LED 5250lm 36W 3000K
Nominal lumens on thermal regime	: 5250
Efficiency L.O.R. (%)	: 85,9
Delivered lumens (lm)	: 4510
Lamp wattage (W)	: 36
Color temperature (K)	: 3000

Physical Specifications

Body	: Die-cast aluminium
Finishes	: Polyester painted
Reflector	: Mirror-metallized thermoplastic material
Closing Screen	: Clear polycarbonate
Thermal Dissipation	: Passive
Ring	: Die-cast aluminium

Electrical Specifications

Glow wire (°C)	: 850
Driver	: Separate item
Driver mounting	: Remote

Weight and Dimensions

Shape	: Round
External diameter (mm)	: 168
False ceiling thickness (mm)	: 1-30
Height (mm)	: 115
Cutout shape	: Round
Cutout Diameter (mm)	: 155
Recessed depth (mm)	: 180
Weight (Kg)	: 2

Optical Specifications

Aiming	: Adjustable
Light distribution	: Symmetric
Light emission	: Direct
Light beam	: 25°
Horizontal orientation	: +/- 40°
Note	: 25°, 60° (mirror metallized), 70° (white) optics are available on demand.

ACCESSORIES



Product Code : 28-3141-31
 Name : Professional optic device 70°
 Finish : White
 Shape : Round



Product Code : 28-3138-51
 Name : Professional optic device 60°
 Finish : Mirror metallized
 Shape : Round



Product Code : 28-3140-51
 Name : Professional optic device 25° (included diffuser)
 Finish : Mirror metallized
 Shape : Round

Drivers

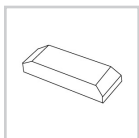





Product Code : 81-04013
 Name : Driver 1050mA

Lamps	Lamp categories	Lamp type	Lamp wattage (W)	Nominal lumens on thermal regime (lm)	Color rendering (CRI)
-------	-----------------	-----------	------------------	---------------------------------------	-----------------------

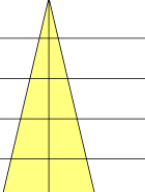
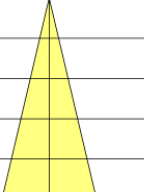
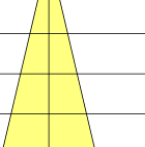
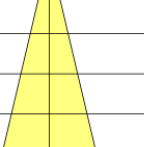
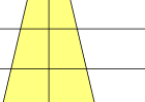
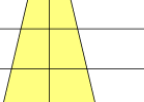

LED	COB LED	36	5250	85
-----	---------	----	------	----

Photometrics

248-24 Gamma Angles 180° 120° 90° 75° 60° 45° 30° 15° 0° 15° 30° cd/klm	RA 17 DIXIT LED 36W 5250 lm				R:100%				I.Max:2670 Cd/Klm					
	H[m]	D[m]	Max lux	Med lux	Alpha=26°	H[m]	D[m]	Max lux	Med lux	Beta=26°	H[m]	D[m]	Max lux	Med lux
	1.00	0.47	12040	7483		1.00	0.47	12040	7483		1.00	0.47	12040	7483
	2.00	0.94	3010	1871		2.00	0.94	3010	1871		2.00	0.94	3010	1871
	3.00	1.42	1338	831		3.00	1.42	1338	831		3.00	1.42	1338	831
	4.00	1.89	752	468		4.00	1.89	752	468		4.00	1.89	752	468
	5.00	2.36	482	299		5.00	2.36	482	299		5.00	2.36	482	299

Pictures and Applications

