



## KARDAN-TL 3000K TWIN LIGHT

Design: Studio Tecnico Ivela



<b>Product code</b>	<b>Color</b>
509-221BN-16	Black

### General Specifications

Product type	: Downlights
Mounting type	: Ceiling - recessed
Description	: A trimless multi-directional lighting system for the last generation of COB LEDs, featuring one adjustable light source. Inner body in black painted steel. LED drivers should be ordered separately, the wattage of the fittings changes, depending on the selected driver.

Indoor/outdoor lights	: Indoor
Applications	: Galleries, Museums, Shop windows

### Lighting specifications

Average lamp life (h)	: L80B10 50.000
Lamp description	: LED 2x2400lm 2x18W 3000K
Nominal lumens on thermal regime	: 2400
Lamp wattage (W)	: 18
Color temperature (K)	: 3000

### Physical Specifications

Body	: Die-cast aluminium
Finishes	: Polyester painted

### Electrical Specifications

Glow wire (°C)	: 850
Driver	: Separate item
Driver mounting	: Remote

### Weight and Dimensions

Shape	: Rectangular
Length (mm)	: 236
Width (mm)	: 112
Height (mm)	: 100
Cutout shape	: Rectangular
Cutout Length (mm)	: 115
Recessed depth (mm)	: 170
Weight (Kg)	: 2

### Optical Specifications

Aiming	: Multidirectional
Light distribution	: Symmetric
Light emission	: Direct
Light beam	: 30°
Note	: 24°, 45° (mirror metallized) optics are available on demand. Honeycomb code 28-4022-30 to be used only together with screen code 28-3905-47.

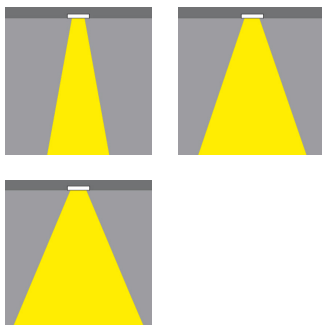
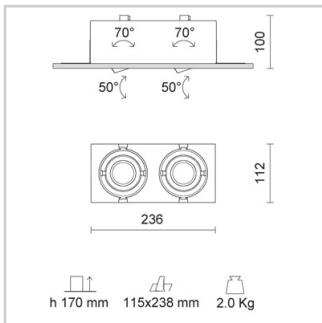

## ACCESSORIES



Product Code : 28-3901-51  
 Name : Professional optic device 24°  
 Finish : Mirror metallized  
 Beam : 24°  
 Shape : Round



Product Code : 28-3903-51  
 Name : Professional optic device 45°  
 Finish : Mirror metallized  
 Beam : 45°  
 Shape : Round



Product Code : 28-3905-47  
 Name : Closing screen in thermoplastic

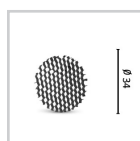

Product Code : 28-4022-30  
 Name : Honeycomb  
 Finish : Black painted  
 Shape : Round  
 Notes : To be used only with closing screen (28-3905-47)

## Drivers

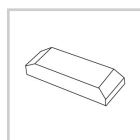

Product Code : 81-04021  
 Name : Driver 1000mA  
 description : Driver 1000mA

Lamps	Lamp categories	Lamp type	Lamp wattage (W)	Nominal lumens on thermal regime (lm)	Color temperature (K)	Color rendering (CRI)
	LED	COB LED	18	2400	3000	85

## Photometrics

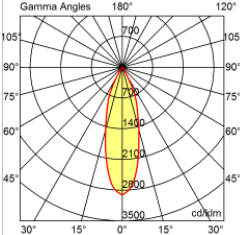
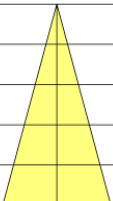
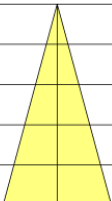
508-2/509-2	KARDAN LED 18W 2400 lm 3000K				R:100%	I.Max:2907 Cd/Klm				
Gamma Angles	H[m]	D[m]	Max lux	Med lux	Alpha=30°	H[m]	D[m]	Max lux	Med lux	Beta=30°
	1.00	0.54	5093	3094		1.00	0.54	5093	3094	
	2.00	1.08	1273	773		2.00	1.08	1273	773	
	3.00	1.62	566	344		3.00	1.62	566	344	
	4.00	2.16	318	193		4.00	2.16	318	193	
	5.00	2.71	204	124		5.00	2.71	204	124	

## Pictures and Applications

