

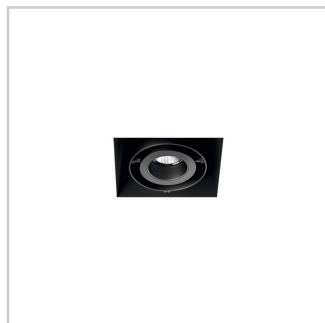

KARDAN-TL 4000K
Design: Studio Tecnico Ivela

Product code	Color
509-211AN-16	Black

General Specifications

Product type	: Downlights
Mounting type	: Ceiling - recessed
Description	: A trimless multi-directional lighting system for the last generation of COB LEDs, featuring one adjustable light source. Inner body in black painted steel. LED drivers should be ordered separately, the wattage of the fittings changes, depending on the selected driver.

Indoor/outdoor lights	: Indoor
Applications	: Galleries, Museums, Shop windows

Lighting specifications

Average lamp life (h)	: L80B10 50.000
Lamp description	: LED 2500lm 18W 4000K
Nominal lumens on thermal regime	: 2500
Lamp wattage (W)	: 18
Color temperature (K)	: 4000

Physical Specifications

Body	: Die-cast aluminium
Finishes	: Polyester painted

Electrical Specifications

Glow wire (°C)	: 850
Driver	: Separate item
Driver mounting	: Remote

Weight and Dimensions

Shape	: Rectangular
Length (mm)	: 122
Width (mm)	: 112
Height (mm)	: 100
Cutout shape	: Rectangular
Cutout Length (mm)	: 115
Recessed depth (mm)	: 170
Weight (Kg)	: 1

Optical Specifications

Aiming	: Multidirectional
Light distribution	: Symmetric
Light emission	: Direct
Light beam	: 30°
Note	: 24°, 45° (mirror metallized) optics are available on demand. Honeycomb code 28-4022-30 to be used only together with screen code 28-3905-47.

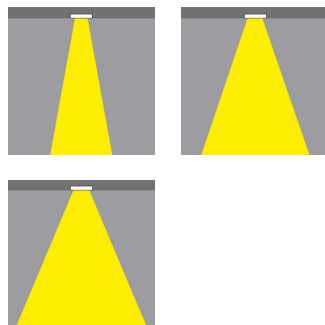
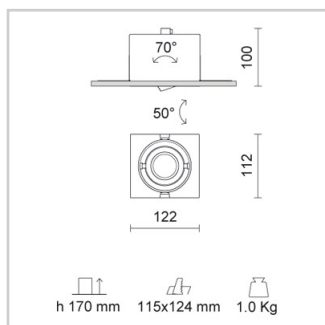

ACCESSORIES



Product Code : 28-3901-51
 Name : Professional optic device 24°
 Finish : Mirror metallized
 Beam : 24°
 Shape : Round



Product Code : 28-3903-51
 Name : Professional optic device 45°
 Finish : Mirror metallized
 Beam : 45°
 Shape : Round



Product Code : 28-3905-47
 Name : Closing screen in thermoplastic

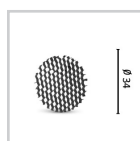

Product Code : 28-4022-30
 Name : Honeycomb
 Finish : Black painted
 Shape : Round
 Notes : To be used only with closing screen (28-3905-47)

Drivers

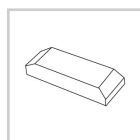

Product Code : 81-04011
 Name : Driver 500mA

Lamps	Lamp categories	Lamp type	Lamp wattage (W)	Nominal lumens on thermal regime (lm)	Color temperature (K)	Color rendering (CRI)
	LED	COB LED	18	2500	4000	85

Photometrics

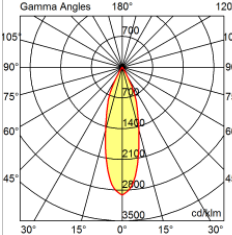
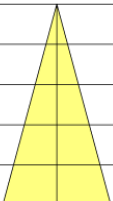
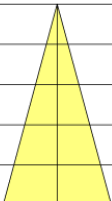
508-2/509-2	KARDAN LED 18W 2500 lm 4000K				R:100%	I.Max:2907 Cd/Klm				
Gamma Angles	H[m]	D[m]	Max lux	Med lux	Alpha=30°	H[m]	D[m]	Max lux	Med lux	Beta=30°
	1.00	0.54	5306	3223		1.00	0.54	5306	3223	
	2.00	1.08	1326	806		2.00	1.08	1326	806	
	3.00	1.62	590	358		3.00	1.62	590	358	
	4.00	2.16	332	201		4.00	2.16	332	201	
	5.00	2.71	212	129		5.00	2.71	212	129	

Pictures and Applications

