



KARDAN-TL 4000K TWIN LIGHT

Design: Studio Tecnico Ivela



Product code	Color
509-221AN-16	Black

General Specifications

Product type	: Downlights
Mounting type	: Ceiling - recessed
Description	: A trimless multi-directional lighting system for the last generation of COB LEDs, featuring one adjustable light source. Inner body in black painted steel. LED drivers should be ordered separately, the wattage of the fittings changes, depending on the selected driver.

Indoor/outdoor lights	: Indoor
Applications	: Galleries, Museums, Shop windows

Lighting specifications

Average lamp life (h)	: L80B10 50.000
Lamp description	: LED 2x1800lm 2x12W 4000K
Nominal lumens on thermal regime	: 1800
Lamp wattage (W)	: 12
Color temperature (K)	: 4000

Physical Specifications

Body	: Die-cast aluminium
Finishes	: Polyester painted

Electrical Specifications

Glow wire (°C)	: 850
Driver	: Separate item
Driver mounting	: Remote

Weight and Dimensions

Shape	: Rectangular
Length (mm)	: 236
Width (mm)	: 112
Height (mm)	: 100
Cutout shape	: Rectangular
Cutout Length (mm)	: 115
Recessed depth (mm)	: 170
Weight (Kg)	: 2

Optical Specifications

Aiming	: Multidirectional
Light distribution	: Symmetric
Light emission	: Direct
Light beam	: 30°
Note	: 24°, 45° (mirror metallized) optics are available on demand. Honeycomb code 28-4022-30 to be used only together with screen code 28-3905-47.

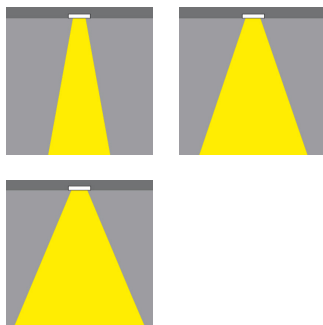
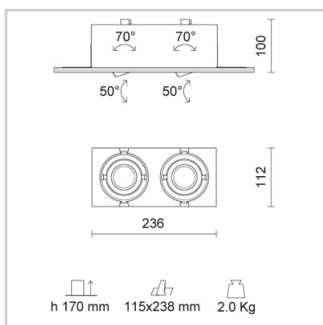

ACCESSORIES



Product Code : 28-3901-51
 Name : Professional optic device 24°
 Finish : Mirror metallized
 Beam : 24°
 Shape : Round



Product Code : 28-3903-51
 Name : Professional optic device 45°
 Finish : Mirror metallized
 Beam : 45°
 Shape : Round



Product Code : 28-3905-47
 Name : Closing screen in thermoplastic

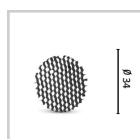

Product Code : 28-4022-30
 Name : Honeycomb
 Finish : Black painted
 Shape : Round
 Notes : To be used only with closing screen (28-3905-47)

Drivers

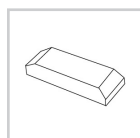

Product Code : 81-04012
 Name : Driver 700mA
 description : Driver 700mA

Lamps	Lamp categories	Lamp type	Lamp wattage (W)	Nominal lumens on thermal regime (lm)	Color temperature (K)	Color rendering (CRI)
	LED	COB LED	12	1800	4000	85

Photometrics

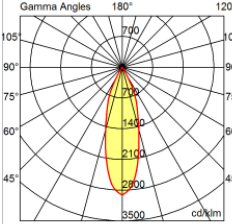
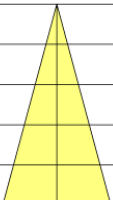
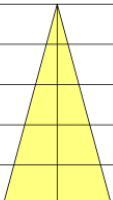
508-2/509-2 	KARDAN LED 12W 1800 lm 4000K				R:100%		I.Max:2907 Cd/Klm			
	H[m]	D[m]	Max lux	Med lux	Alpha=30°	H[m]	D[m]	Max lux	Med lux	Beta=30°
	1.00	0.54	3820	2320		1.00	0.54	3820	2320	
	2.00	1.08	955	580		2.00	1.08	955	580	
	3.00	1.62	424	258		3.00	1.62	424	258	
	4.00	2.16	239	145		4.00	2.16	239	145	
	5.00	2.71	153	93		5.00	2.71	153	93	

Pictures and Applications

