



Product code	Color
256-200BN-21	Mat white

General Specifications

Product type	: Downlights
Mounting type	: Ceiling - recessed
Description	: Adjustable downlight for diffused lighting designed for the last generation of COB LEDs, with a shallow depth. LED drivers should be ordered separately, the wattage of the fittings changes depending on the selected driver. Protection rating IP20. Low glare levels UGR < 19 (Unified Glare Rating).
Indoor/outdoor lights	: Indoor
Applications	: Offices, Retail , Shopping centres

Lighting specifications

Average lamp life (h)	: L80B10 50.000
Lamp description	: LED 1700lm 12W 3000K
Nominal lumens on thermal regime	: 1700
Efficiency L.O.R. (%)	: 89,0
Delivered lumens (lm)	: 1513
Lamp wattage (W)	: 12
Color temperature (K)	: 3000

Physical Specifications

Body	: Die-cast aluminium
Finishes	: Polyester painted
Reflector	: Mirror-metallized thermoplastic material
Closing Screen	: Clear polycarbonate
Thermal Dissipation	: Passive
Ring	: Die-cast aluminium

Electrical Specifications

Glow wire (°C)	: 850
Driver	: Separate item
Driver mounting	: Remote

Weight and Dimensions

Shape	: Round
External diameter (mm)	: 125
False ceiling thickness (mm)	: 1-30
Height (mm)	: 79
Cutout shape	: Round
Cutout Diameter (mm)	: 116
Recessed depth (mm)	: 79
Weight (Kg)	: 0.7

Optical Specifications

Aiming	: Adjustable
Light distribution	: Symmetric
Light emission	: Direct
Light beam	: 55°
Horizontal orientation	: +/- 20°
Note	: 18°, 30° (mirror metallized), 70° (white) optics are available on demand.
Unified Glare Rating (U.G.R.)	: <19

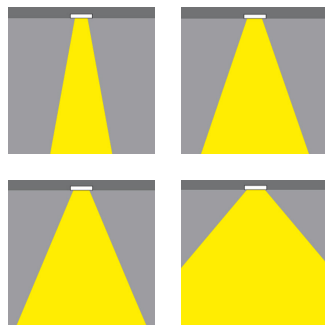
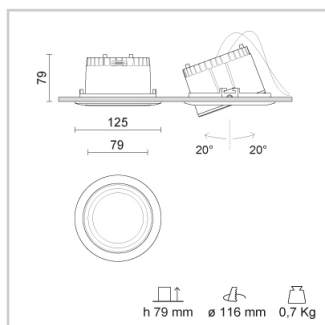

ACCESSORIES



Product Code : 28-3142-51
 Name : Professional optic device 30°
 Finish : Mirror metallized
 Shape : Round



Product Code : 28-3141-31
 Name : Professional optic device 70°
 Finish : White
 Shape : Round



Product Code : 28-3140-51
 Name : Professional optic device 18° (included diffuser)
 Finish : Mirror metallized
 Shape : Round

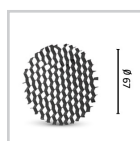

Product Code : 28-4019-30
 Name : Honeycomb
 Finish : Black painted
 Shape : Round

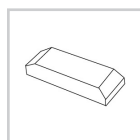

Drivers



Product Code : 81-04010
 Name : Driver 350mA dimmable on the mains

Lamps	Lamp categories	Lamp type	Lamp wattage (W)	Nominal lumens on thermal regime (lm)	Color temperature (K)	Color rendering (CRI)
	LED	COB LED	12	1700	3000	85

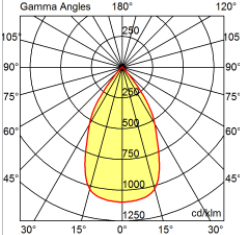
Photometrics

255-2 / 256-2	RA 11 DIXIT LED 12W 1700LM 3000K				R:100%	I.Max:1096 Cd/Klm				
Gamma Angles	H[m]	D[m]	Max lux	Med lux	Alpha=55°	H[m]	D[m]	Max lux	Med lux	Beta=55°
	1.00	1.13	1658	898		1.00	1.13	1658	898	
	2.00	2.26	415	224		2.00	2.26	415	224	
	3.00	3.38	184	100		3.00	3.38	184	100	
	4.00	4.51	104	56		4.00	4.51	104	56	
	5.00	5.64	66	36		5.00	5.64	66	36	

Pictures and Applications

