



Product code	Color
256-200AN-21	Mat white

General Specifications

Product type	: Downlights
Mounting type	: Ceiling - recessed
Description	: Adjustable downlight for diffused lighting designed for the last generation of COB LEDs, with a shallow depth. LED drivers should be ordered separately, the wattage of the fittings changes depending on the selected driver. Protection rating IP20. Low glare levels UGR < 19 (Unified Glare Rating).
Indoor/outdoor lights	: Indoor
Applications	: Offices, Retail , Shopping centres

Lighting specifications

Average lamp life (h)	: L80B10 50.000
Lamp description	: LED 2450lm 18W 4000K
Nominal lumens on thermal regime	: 2450
Efficiency L.O.R. (%)	: 89,0
Delivered lumens (lm)	: 2180
Lamp wattage (W)	: 18
Color temperature (K)	: 4000

Physical Specifications

Body	: Die-cast aluminium
Finishes	: Polyester painted
Reflector	: Mirror-metallized thermoplastic material
Closing Screen	: Clear polycarbonate
Thermal Dissipation	: Passive
Ring	: Die-cast aluminium

Electrical Specifications

Glow wire (°C)	: 850
Driver	: Separate item
Driver mounting	: Remote

Weight and Dimensions

Shape	: Round
External diameter (mm)	: 125
False ceiling thickness (mm)	: 1-30
Height (mm)	: 79
Cutout shape	: Round
Cutout Diameter (mm)	: 116
Recessed depth (mm)	: 79
Weight (Kg)	: 0.7

Optical Specifications

Aiming	: Adjustable
Light distribution	: Symmetric
Light emission	: Direct
Light beam	: 55°
Horizontal orientation	: +/- 20°
Note	: 18°, 30° (mirror metallized), 70° (white) optics are available on demand.
Unified Glare Rating (U.G.R.)	: <19

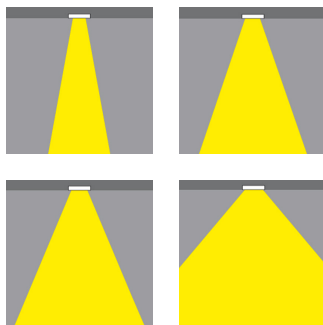
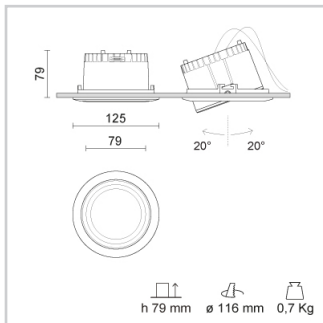

ACCESSORIES



Product Code : 28-3142-51
 Name : Professional optic device 30°
 Finish : Mirror metallized
 Shape : Round



Product Code : 28-3141-31
 Name : Professional optic device 70°
 Finish : White
 Shape : Round



Product Code : 28-3140-51
 Name : Professional optic device 18° (included diffuser)
 Finish : Mirror metallized
 Shape : Round

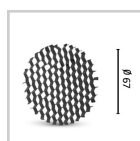

Product Code : 28-4019-30
 Name : Honeycomb
 Finish : Black painted
 Shape : Round

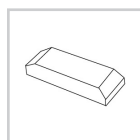

Drivers



Product Code : 81-04011
 Name : Driver 500mA
 description : Driver 500mA

Lamps	Lamp categories	Lamp type	Lamp wattage (W)	Nominal lumens on thermal regime (lm)	Color temperature (K)	Color rendering (CRI)
	LED	COB LED	18	2450	4000	85

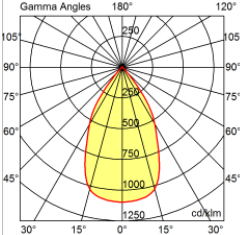
Photometrics

255-2 / 256-2	RA 11 DIXIT LED 18W 2450lm 4000K				R:100%	I.Max:1096 Cd/Klm				
Gamma Angles	H[m]	D[m]	Max lux	Med lux	Alpha=58°	H[m]	D[m]	Max lux	Med lux	Beta=58°
	1.00	1.13	2391	1294		1.00	1.13	2391	1294	
	2.00	2.26	598	324		2.00	2.26	598	324	
	3.00	3.38	266	144		3.00	3.38	266	144	
	4.00	4.51	149	81		4.00	4.51	149	81	
	5.00	5.64	96	52		5.00	5.64	96	52	

Pictures and Applications

