

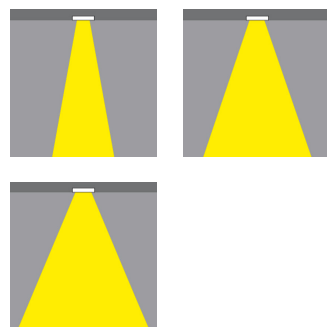

## KARDAN-IN 3000K TWIN LIGHT

Design: Studio Tecnico Ivela

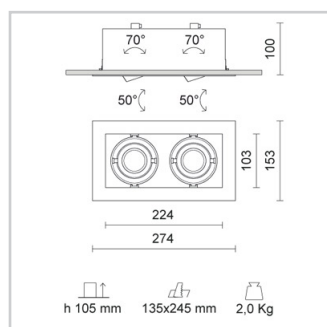

Product code	Color
508-221BN-21	Mat white

### General Specifications

Product type	: Downlights
Mounting type	: Ceiling - recessed
Description	: A multi-directional lighting system with a decorative frame for the last generation of COB LEDs, featuring two adjustable light sources. Inner body in black painted steel. LED drivers should be ordered separately, the wattage of the fittings changes, depending on the selected driver.
Indoor/outdoor lights	: Indoor
Applications	: Galleries, Museums, Shop windows

### Lighting specifications

Average lamp life (h)	: L80B10 50.000
Lamp description	: LED 2x1700lm 2x12W 3000K
Nominal lumens on thermal regime	: 1700
Lamp wattage (W)	: 12
Color temperature (K)	: 3000

### Physical Specifications

Body	: Die-cast aluminium
Finishes	: Polyester painted
Frame	: Steel frame, polyester painted

### Electrical Specifications

Glow wire (°C)	: 850
Driver	: Separate item
Driver mounting	: Remote

### Weight and Dimensions

Shape	: Rectangular
Length (mm)	: 274
Width (mm)	: 153
Height (mm)	: 100
Cutout shape	: Rectangular
Cutout Length (mm)	: 135
Recessed depth (mm)	: 105
Weight (Kg)	: 2

### Optical Specifications

Aiming	: Multidirectional
Light distribution	: Symmetric
Light emission	: Direct
Light beam	: 30°
Note	: 24°, 45° (mirror metallized) optics are available on demand. Honeycomb code 28-4022-30 to be used only together with screen code 28-3905-47.

## ACCESSORIES



Product Code : 28-3901-51  
 Name : Professional optic device 24°  
 Finish : Mirror metallized  
 Beam : 24°  
 Shape : Round



Product Code : 28-3903-51  
 Name : Professional optic device 45°  
 Finish : Mirror metallized  
 Beam : 45°  
 Shape : Round



Product Code : 28-3905-47  
 Name : Closing screen in thermoplastic

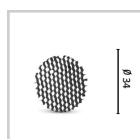

Product Code : 28-4022-30  
 Name : Honeycomb  
 Finish : Black painted  
 Shape : Round  
 Notes : To be used only with closing screen (28-3905-47)

## Drivers

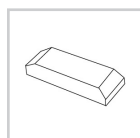

Product Code : 81-04012  
 Name : Driver 700mA  
 description : Driver 700mA

Lamps	Lamp categories	Lamp type	Lamp wattage (W)	Nominal lumens on thermal regime (lm)	Color temperature (K)	Color rendering (CRI)
	LED	COB LED	12	1700	3000	85

## Photometrics

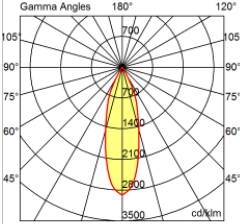
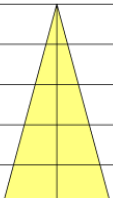
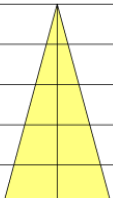
508-2/509-2 	KARDAN LED 12W 1700 lm 3000K				R:100%				I.Max:2907 Cd/Klm			
	H[m]	D[m]	Max lux	Med lux	Alpha=30°	H[m]	D[m]	Max lux	Med lux	Beta=30°		
	1.00	0.54	3608	2192		1.00	0.54	3608	2192			
	2.00	1.08	902	548		2.00	1.08	902	548			
	3.00	1.62	401	244		3.00	1.62	401	244			
	4.00	2.16	225	137		4.00	2.16	225	137			
	5.00	2.71	144	88		5.00	2.71	144	88			

## Pictures and Applications

