

**PERFETTO COMPACT 4000K**
*Design: Studio Tecnico Ivela*

| Product code | Colour            |
|--------------|-------------------|
| 751-261A-21  | Mat white         |
| 751-261A-16  | Black             |
| 751-261A-52  | Silver, on demand |

**General Specifications**

|               |   |
|---------------|---|
| Product type  | : Spotlights  |
| Mounting type | : LKM 3-phase track   |
| Description   | : Spotlight for LKM 3-phase electrified tracks, specially developed for high efficiency COB LEDs. It can rotate up to 355° with respect to the vertical axis and pivot up to 90° upwards. |

|                       |  |
|-----------------------|--|
| Indoor/outdoor lights | : Indoor                                       |
| Applications          | : Museums, Retail, Shopping centres, Showrooms |

**Lighting specifications**

|                                  |                        |
|----------------------------------|------------------------|
| Average lamp life (h)            | : 50.000               |
| Lamp description                 | : LED 3200lm 26W 4000K |
| Nominal lumens on thermal regime | : 3200                 |
| Lamp wattage (W)                 | : 26                   |
| Color temperature (K)            | : 4000                 |

**Physical Specifications**

|                     |  |
|---------------------|--|
| Body                | : Die-cast aluminium                       |
| Finishes            | : Polyester painted                        |
| Reflector           | : Mirror-metallized thermoplastic material |
| Thermal Dissipation | : Passive                                  |

**Electrical Specifications**

|                 |              |
|-----------------|--------------|
| Glow wire (°C)  | : 850        |
| Driver          | : Included   |
| Driver mounting | : Integrated |
| Voltage (V)     | : 220/240    |
| Frequency (Hz)  | : 50/60      |

**Weight and Dimensions**





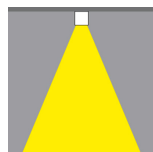
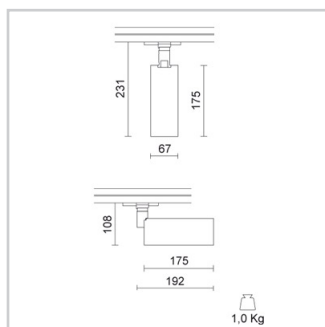

|             |               |
|-------------|---------------|
| Shape       | : Cylindrical |
| Width (mm)  | : 67          |
| Height (mm) | : 231         |
| Weight (Kg) | : 1           |

**Optical Specifications**

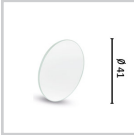
|                        |   |
|------------------------|---|
| Light distribution     | : Symmetric   |
| Light emission         | : Direct  |
| Light beam             | : 29°   |
| Horizontal orientation | : 350°  |
| Note                   | : Honeycomb code 28-9005-30, pink tempered glass for food applications code 28-9006-32, closing screen cod. 28-3905-47 to be used only together with snoot code 28-9004-30. 20°, 42° (mirror metallized), 61° (white) optics are available on demand. |

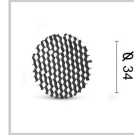

## Accessories

|  |   |   |   |   |   |  |
|--|---|---|---|---|---|--|
|  |  |  |  |  |  |  |
| 28-3905-47<br>Closing screen in thermoplastic                                    | 28-9004-30<br>Snoot   | 28-9005-30<br>Honeycomb   | 28-9006-32<br>Pink tempered glass for food applications                           | 28-3903-51<br>Professional optic device 42°                                       | 28-3903-31<br>Professional optic device 61°                                       | 28-3901-51<br>Professional optic device 20°  |

| Lamps   | Lamp categories | Lamp type | Lamp wattage (W) | Nominal lumens on thermal regime (lm) | Color rendering (CRI) |
|---|-----------------|-----------|------------------|---------------------------------------|-----------------------|
|  | LED             | COB LED   | 26               | 3200                                  | 85                    |

## Pictures and Applications

