



LIGHT KIT MAIN RECESSED 3MT



Product code	Colour
7512-30-30	Black
7512-30-31	White
7512-30-42	Satin silver

General Specifications

Product type	: Tracks
Mounting type	: Ceiling - recessed
Description	: 3-phase tracks
Indoor/outdoor lights	: Indoor

Physical Specifications

Load capacity (Kg)	: The track has a load capacity of 2Kg every 200mm, with a maximum distance of 800mm between the fixing points. For a 10Kg load every 200mm, a maximum fixing distance of 400 mm is recommended.
--------------------	--------------------------------------------------------------------------------------------------------------------------------------------------------------------------------------------------

Electrical Specifications



Current (A)	: 16
Glow wire (°C)	: 850
Voltage (V)	: 230/440

Weight and Dimensions

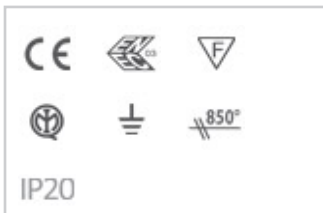
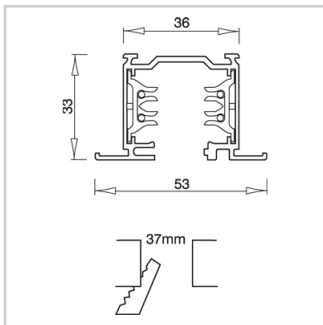
Length (mm)	: 3000
Width (mm)	: 53
Recessed depth (mm)	: 37

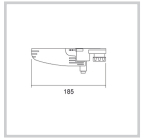
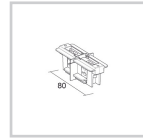
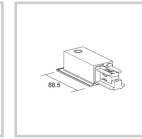
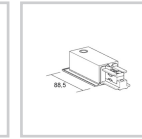

Accessories

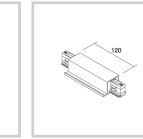
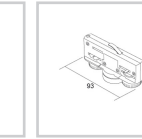
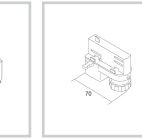
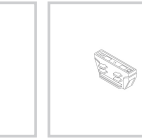
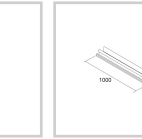
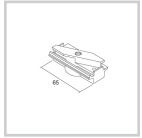
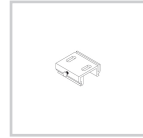
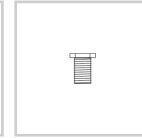
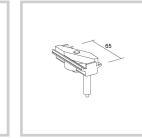
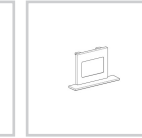
									
7601-11-30/31 Adapter	7654-10-W30/31 Mechanical straight joint	7662-10-W20/30/31 Right live-end	7662-11-W20/30/31 Left live-end	7664-00-48 Suspension for false ceiling	7663-10-W20/30/31 Central connector and straight joint	7600-00-20/30/31 Electro/mechanical adapter	7601-00-W20/30/31 Mechanical/electrical adapter	7604-10-W30/31 Electrical straight joint	7624-00-30/31 Track cover
									
7625-00-30/31/52 Mechanical adapter	7607-00-00 Ceiling kit	7609-00-00 Nut	7618-00-30/31/52 Mechanical adapter with automatic locking	76591-00-W20/30/31 Dead end					

Pictures and Applications

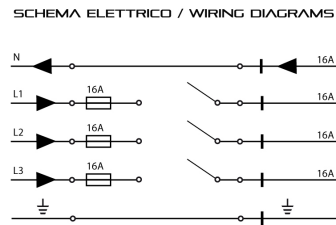
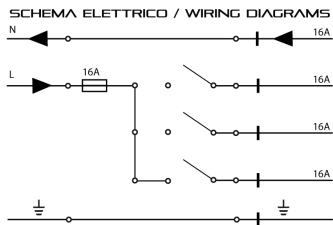

CAPACITÀ DI CARICO / LOAD CAPACITY

