



LIGHT KIT MAIN RECESSED 4MT



| Product code | Colour |
|--------------|--------------|
| 7512-40-30 | Black |
| 7512-40-31 | White |
| 7512-40-42 | Satin silver |

General Specifications

| | |
|-----------------------|----------------------|
| Product type | : Tracks |
| Mounting type | : Ceiling - recessed |
| Description | : 3-phase tracks |
| Indoor/outdoor lights | : Indoor |

Physical Specifications

| | |
|--------------------|--|
| Load capacity (Kg) | : The track has a load capacity of 2Kg every 200mm, with a maximum distance of 800mm between the fixing points. For a 10Kg load every 200mm, a maximum fixing distance of 400 mm is recommended. |
|--------------------|--|

Electrical Specifications



| | |
|----------------|-----------|
| Current (A) | : 16 |
| Glow wire (°C) | : 850 |
| Voltage (V) | : 230/440 |

Weight and Dimensions

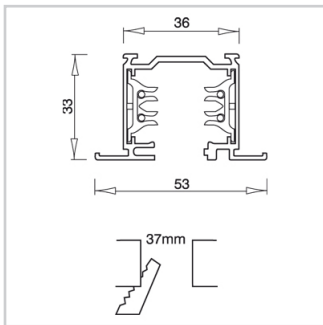
| | |
|---------------------|--------|
| Length (mm) | : 4000 |
| Width (mm) | : 53 |
| Recessed depth (mm) | : 37 |

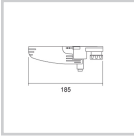
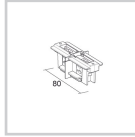
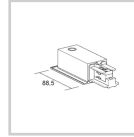
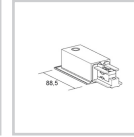
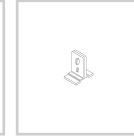
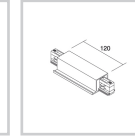
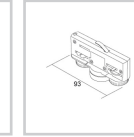
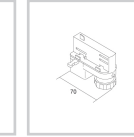

Accessories

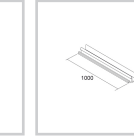
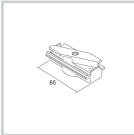
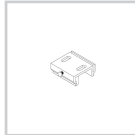
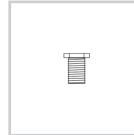
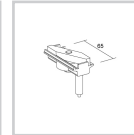
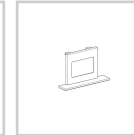
| | | | | | | | | | |
|--|---|---|---|---|---|--|---|---|---|
|  |  |  |  |  |  |  |  |  |  |
| 7601-11-30/31 Adapter | 7654-10- W30/31 Mechanical straight joint | 7662-10- W20/30/31 Right live-end | 7662-11- W20/30/31 Left live-end | 7664-00-48 Suspension for false ceiling | 7663-10- W20/30/31 Central connector and straight joint | 7600-00- 20/30/31 Electro/mech anical adapter | 7601-00- W20/30/31 Mechanical/el ectrical adapter | 7604-10- W30/31 Electrical straight joint | 7624-00- 30/31 Track cover |
|  |  |  |  |  | | | | | |
| 7625-00- 30/31/52 Mechanical adapter | 7607-00-00 Ceiling kit | 7609-00-00 Nut | 7618-00- 30/31/52 Mechanical adapter with automatic locking | 76591-00- W20/30/31 Dead end | | | | | |

Pictures and Applications

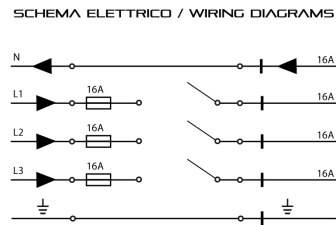
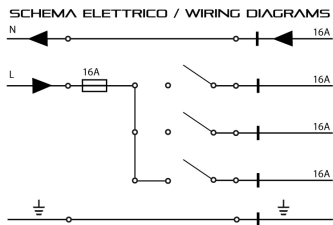

CAPACITÀ DI CARICO / LOAD CAPACITY

