



LIGHT KIT E.L.V. 1MT



Product code	Colour
6501-10-30	Black
6501-10-31	White
6501-10-42	Satin silver
6501-10-10	Gold

General Specifications

Product type	: Tracks
Mounting type	: Ceiling - surface, Pendant
Description	: Low-voltage tracks
Indoor/outdoor lights	: Indoor

Physical Specifications

Load capacity (Kg)	: Load capacity per linear metre.
--------------------	-----------------------------------

Electrical Specifications



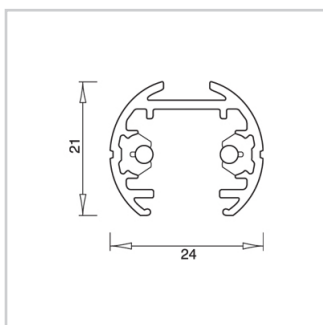

Current (A)	: 25
Voltage (V)	: 12

Weight and Dimensions

Length (mm)	: 1000
Width (mm)	: 24
Height (mm)	: 21

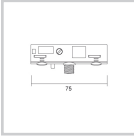
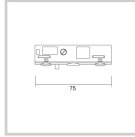
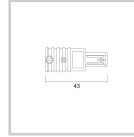

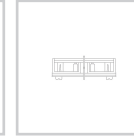
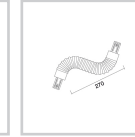
Accessories

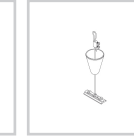
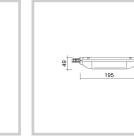
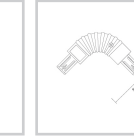
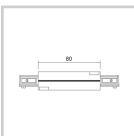
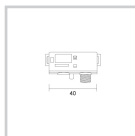
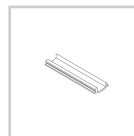
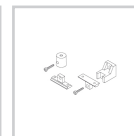
									
6620-00-30/31 Cable/pipe	6620-10-30/31 Cable/pipe	6602-00-30/31 Live-end	6604-00-30/31 Straight connector	6619-10-30/31 Mechanical connector	6610-00-30/31 Flexible connector	6623-00-30/31 Dead end	6606-00-30/31 Suspension kit	6650-03-30/31 Electronic transformer	6605-00-30/31 L joint
									
6603-00-30/31 Central connector	6601-00-30/31 Jack adapter 12V-5A	6624-00-30/31 Track cover	6607-20-30/31 Ceiling/wall mounting kit (set 2 pz.)						

Pictures and Applications

