



## MINI MAIN 3MT



Product code	Colour
7701-30-30	Black
7701-30-31	White
7701-30-42	Satin silver

### General Specifications

Product type	: Tracks
Mounting type	: Ceiling - surface, Pendant
Description	: Single-phase tracks
Indoor/outdoor lights	: Indoor

### Physical Specifications

Load capacity (Kg)	: The track has a load capacity of 4Kg every 1000mm. For a 7Kg load, a maximum fixing distance of 500mm is recommended.
--------------------	---

### Electrical Specifications

Current (A)	: 16
Glow wire (°C)	: 850
Voltage (V)	: 230/250

### Weight and Dimensions

Length (mm)	: 3000
Width (mm)	: 30
Height (mm)	: 22

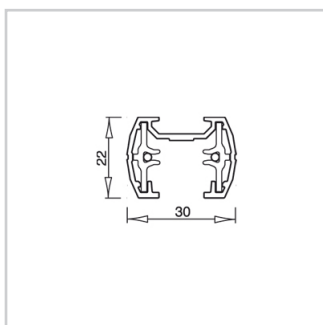

## Accessories

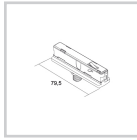

7800-00-20/30/31  
Electro/mechanical

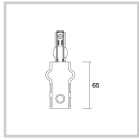

7802-00-W20/30/31  
Live-end connector



7805-00-W20/30/31  
L joint

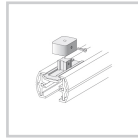

7807-02-W30/31  
Wall/ceiling kit pair



7823-00-W20/30/31  
Dead end

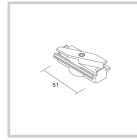

7825-00-30/31/52  
Mechanical adapter

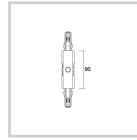

7803-00-W20/30/31  
Central connector

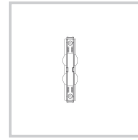

7804-00-W30/31  
Electrical straight joint

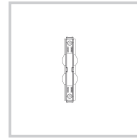

7819-00-W30/31  
Mechanical straight joint

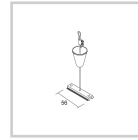

7806-00-30/31  
Suspension kit



7810-00-W  
Flexible joint



7801-11-30/31  
Adapter

## Pictures and Applications

SCHEMA ELETTRICO / WIRING DIAGRAMS

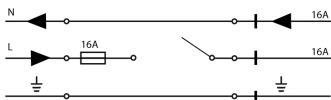

CAPACITÀ DI CARICO / LOAD CAPACITY

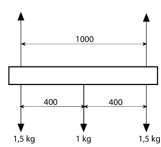

CAPACITÀ DI CARICO / LOAD CAPACITY

