

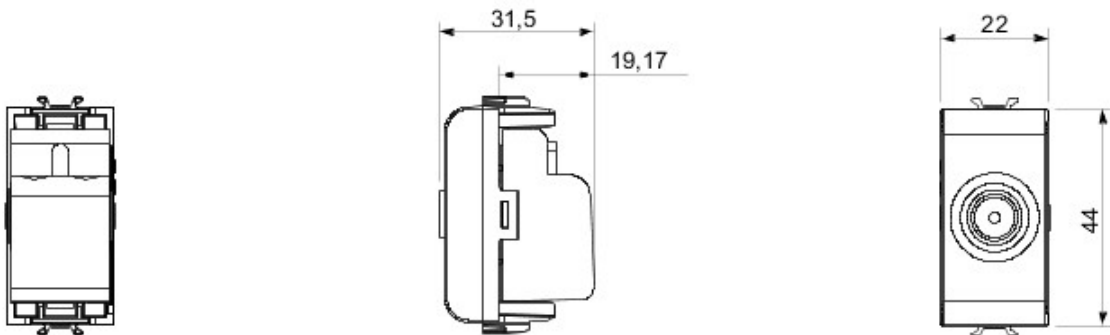

Wide range of switches, energy sockets (compliant with national and international standards), data sockets, devices for the management of climate control, comfort, technical alarms signalling, emergency lighting. The Chorus modular devices are available in four colors, glossy white, satin black, painted titanium and glossy ivory and in different modularities, 1/2, 1, 2 and 3 modules. Thanks to the frame supports for rectangular, square and round boxes, the devices allow you to create endless combinations with the range of Chorus plates.

Category	TV socket-outlet	Description	Feedthrough
Colour	Black	Attenuation	5 dB
Frequency	5-2400 MHz	Shielding	Class A
For connector type	IEC-Male	Standard	EN 60728-4; IEC 61169-2
No. Chorus modules	1	Cable fixing	With screw
Case	Pressure casting zamak metal body	Electrocod	0131

DIMENSIONAL



STANDARDS/APPROVALS



GEWISS S.p.A. Via A. Volta, 1
24069 Cenate Sotto - Bergamo - Italy
tel. +39 035 94 61 11 fax +39 035 94 69 09

www.gewiss.com
sat@gewiss.com
Last update 13/07/2018

Data, measures, designs and pictures are shown only as informativ purposes, and could be changed without previous notice