

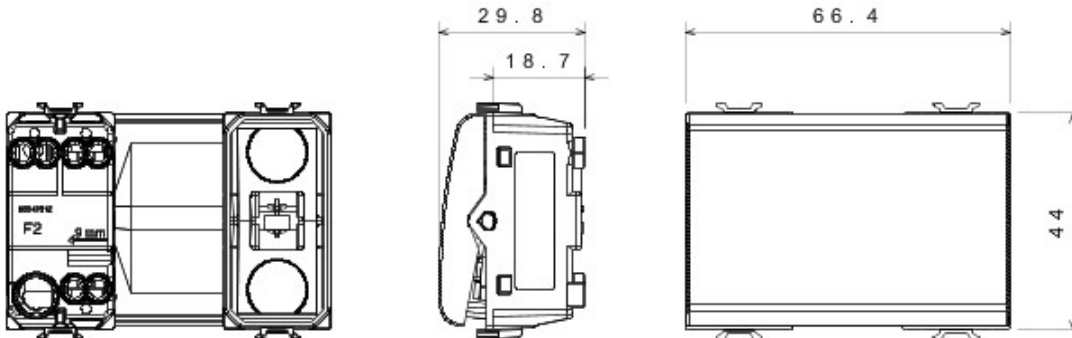

Wide range of switches, energy sockets (compliant with national and international standards), data sockets, devices for the management of climate control, comfort, technical alarms signalling, emergency lighting. The Chorus modular devices are available in four colors, glossy white, satin black, painted titanium and glossy ivory and in different modularities, 1/2, 1, 2 and 3 modules. Thanks to the frame supports for rectangular, square and round boxes, the devices allow you to create endless combinations with the range of Chorus plates.

Category	One-way switch	Button key	With diffuser
Colour	Black	Description	1P - 16AX illuminable
Voltage	250 V ac	Standard	EN 60669-1
Resistance at test voltage	2000 V a 50 Hz for 1 minut	Insulation resistance	> 5 MOhm
Wiring terminals	With screw	Breaking capacity	1.25 In (200 position changes)
Prolonged operation (no.of position changes)	40.000 at In 250 V ac cosØ=0,6	Thermo-pressure with ball	125 °C
Glow Wire Test	850 °C	Terminal grip on cable traction	> 50 N
Terminal tightening capacity flexible cables (mm2)	min. 0,75 - max. 2x4	Terminal tightening capacity rigid cables (mm2)	min. 0,5 - max. 2x2,5
No. Chorus modules	3	Electrocod	0130

DIMENSIONAL



TECHNICAL SYMBOLOGY



125 °C



850 °C

STANDARDS/APPROVALS

