

PRODUCT DATASHEET QT-FIT5 3X14,4X14

QUICKTRONIC FIT 5 | ECG for FL 16 mm



AREAS OF APPLICATION

- Open-plan offices, corridors and storage rooms
- Public buildings
- Strip lighting
- Suitable for emergency lighting (DC operation)
- Suitable for luminaires of protection class I
- Modernization of existing systems

PRODUCT BENEFITS

- Long lamp life
- No adverse effect from frequent on/off switching
- Automatic restart after lamp replacement
- Perfect lamp start for applications with motion sensors
- VDE/VDE EMC certified system
- Very high energy efficiency due to cut-off technology

PRODUCT FEATURES

- Supply voltage: 220...240 V
- Line voltage: 198...264 V
- Line frequency: 50 Hz | 60 Hz
- Lamp start with optimum filament preheating
- Energy Efficiency Index EEI: A2
- Automatic shutdown of defective lamps and at end of life (EoL T.2)
- Lamp operation: to EN 60929
- Safety: to EN 61347-2-3

TECHNICAL DATA

Electrical data

Input voltage AC	198...264 V
Nominal voltage	220...240 V
Mains frequency	50...60 Hz
Input voltage DC	185...264 V ¹⁾
Operating frequency	40...50 kHz
Max. ECG no. on circuit breaker 10 A (B)	12 ²⁾
Max. ECG no. on circuit breaker 16 A (B)	19 ²⁾
Inrush current	40 A

¹⁾ Minimum voltage for lamp ignition: 198 V, 185...198 V for maximum 1 h

²⁾ Type B

Light technical data

Starting time	2.0 s
----------------------	-------

Dimensions & weight

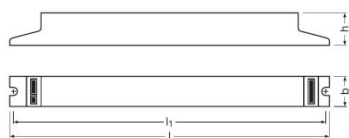

Length	280.0 mm
Width	40.0 mm
Height	21.0 mm
Mounting hole spacing, length	270.0 mm
Product weight	202.00 g
Cable cross-section, output side	0.5...1.5 mm ² ¹⁾
Cable cross-section, input side	0.5...1.5 mm ² ¹⁾

¹⁾ Solid leads

Temperatures & operating conditions

Ambient temperature range	-15...+50 °C
Permitted rel. humidity during operation	5...85 %

Lifespan

ECG lifetime	50000 h
---------------------	---------

Capabilities

Suitable for fixtures with prot. class	I
End of lamp life safety shutdown	EOL T.2

Certificates & standards

Approval marks – approval	VDE / ENEC 10 / VDE-EMC
EEI – Energy Label	A2 BAT
Standards	Acc. to EN 61347-2-3/IEC 61347-2-3/Acc. to EN 55015:2006 + A1:2007 + A2:2009/Acc. to EN 61000-3-2/IEC 61000-3-2/Acc. to EN 61547/IEC 61547
Protection class	I
Type of protection	IP20



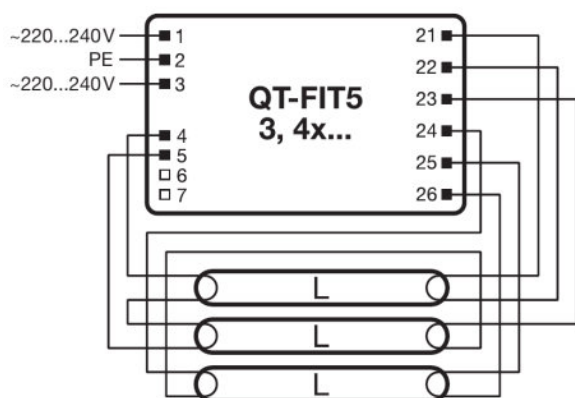









Wiring Diagram



Wiring diagram

DOWNLOAD DATA

File	
	Product Datasheet 502688_ECG lifetime - QUICKTRONIC non DIM

	Product Datasheet 342812_QT-FIT5
	Certificates 554891_EAC PT family
	Certificates 339586_VDE-Marks approval
	Certificates 339588_EMC-Marks approval
	Certificates 683441_ENEC-Marks approvals
	Declarations of conformity 339525_Declaration of Conformity (GB)
	Operating instructions 592456_EAC QT-FIT5
	Operating instructions 592456_EAC QT-FIT5
	CAD data 3-dim 339654_CAD QT-FIT5 3-DIM.x_t
	CAD data 3-dim 339655_CAD QT-FIT5 3-DIM.STEP
	CAD data 3-dim 339656_CAD QT-FIT5 3-DIM.IGS
	CAD data PDF 339662_CAD QT-FIT5

LOGISTICAL DATA

Product code	Product description	Packaging unit (Pieces/Unit)	Dimensions (length x width x height)	Volume	Gross weight
4008321971210	QT-FIT5 3X14,4X14	Shipping carton box 20	300 mm x 118 mm x 168 mm	5.95 dm ³	4217.00 g

The mentioned product code describes the smallest quantity unit which can be ordered. One shipping unit can contain one or more single products. When placing an order, for the quantity please enter single or multiples of a shipping unit.

DISCLAIMER

Subject to change without notice. Errors and omission excepted. Always make sure to use the most recent release.

QUICKTRONIC FIT 5 | ECG for FL 16 mm

Product name	Lamp group	Nominal current	Nominal wattage + Power loss	Luminous flux at 35 °C	Number of lighting outlets
QT-FIT5 3X14,4X14	HE 13 W ES	0.19 A	43.00 W	1150 lm	3
	HE 13 W ES	0.25 A	55.00 W	1150 lm	4
	HE 14 W	0.28 A	63.00 W	1200 lm	4