



## LIGHT KIT MAIN SQUARE 2MT



Product code	Colour
--------------	--------

7511-20-30	Black
7511-20-31	White
7511-20-42	Satin silver

### General Specifications

Product type	: Tracks
Mounting type	: Ceiling - surface, Pendant
Description	: 3-phase tracks
Indoor/outdoor lights	: Indoor

### Physical Specifications

Load capacity (Kg)	: The track has a load capacity of 2Kg every 200mm, with a maximum distance of 800mm between the fixing points. For a 10Kg load every 200mm, a maximum fixing distance of 400 mm is recommended.
--------------------	--------------------------------------------------------------------------------------------------------------------------------------------------------------------------------------------------

### Electrical Specifications

Current (A)	: 16
Glow wire (°C)	: 850
Voltage (V)	: 230/440

### Weight and Dimensions

Shape	: Square
Length (mm)	: 2000
Width (mm)	: 36
Height (mm)	: 33

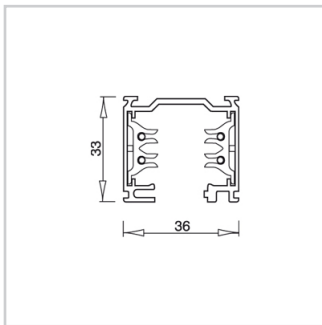

## Accessories

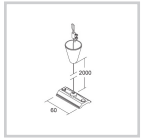

7606-00-30/31  
Suspension kit

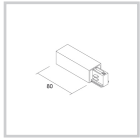

7652-10-W20/30/31  
Right live-end

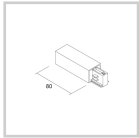

7652-11-W20/30/31  
Left live-end

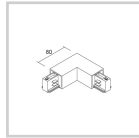

7655-10-W20/30/31  
Inside L joint

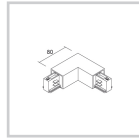

7655-11-W20/30/31  
Outside L joint

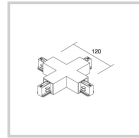

7657-10-W20/30/31  
X joint

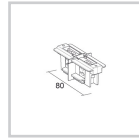

7654-10-W30/31  
Mechanical straight joint

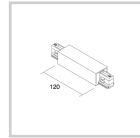

7653-10-W20/30/31  
Central connector and straight joint

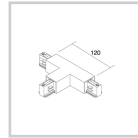

7656-10-W20/30/31  
Right T joint

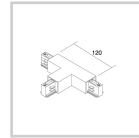

7656-11-W20/30/31  
Left T joint

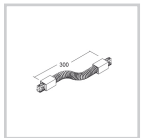

7658-10-W20/30/31  
Flexible joint

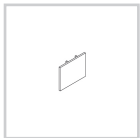

7659-00-W20/30/31  
Dead end

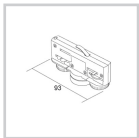

7600-00-20/30/31  
Electro/mechanical adapter

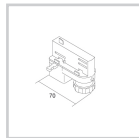

7601-00-W20/30/31  
Mechanical/electrical adapter

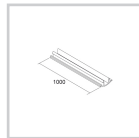

7624-00-30/31  
Track cover

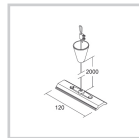

7606-05-30/31  
Suspension kit

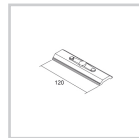

7606-04-00  
Plate

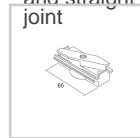

7625-00-30/31/52  
Mechanical adapter

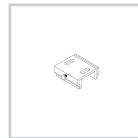

7607-00-00  
Ceiling kit

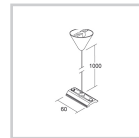

7626-00-00  
Suspension kit

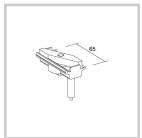

7618-00-30/31/52  
Mechanical adapter with automatic locking

## Pictures and Applications

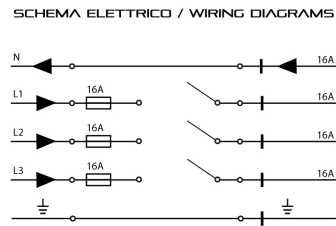
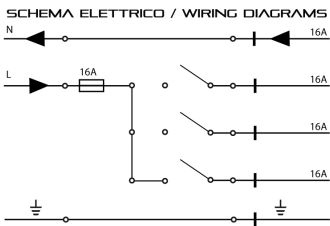

**CAPACITÀ DI CARICO / LOAD CAPACITY**

