



LIGHT KIT MAIN SQUARE 1MT



Product code	Colour
--------------	--------

7511-10-30	Black
7511-10-31	White
7511-10-42	Satin silver

General Specifications

Product type	: Tracks
Mounting type	: Ceiling - surface, Pendant
Description	: 3-phase tracks
Indoor/outdoor lights	: Indoor

Physical Specifications

Load capacity (Kg)	: The track has a load capacity of 2Kg every 200mm, with a maximum distance of 800mm between the fixing points. For a 10Kg load every 200mm, a maximum fixing distance of 400 mm is recommended.
--------------------	--

Electrical Specifications

Current (A)	: 16
Glow wire (°C)	: 850
Voltage (V)	: 230/440

Weight and Dimensions

Shape	: Square
Length (mm)	: 1000
Width (mm)	: 36
Height (mm)	: 33

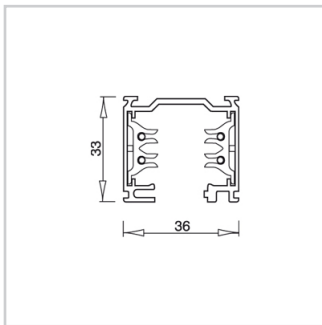

Accessories

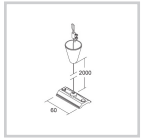

7606-00-30/31
Suspension kit

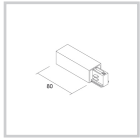

7652-10-W20/30/31
Right live-end

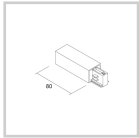

7652-11-W20/30/31
Left live-end

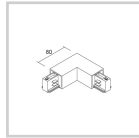

7655-10-W20/30/31
Inside L joint

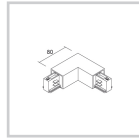

7655-11-W20/30/31
Outside L joint

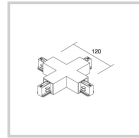

7657-10-W20/30/31
X joint

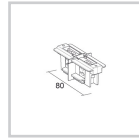

7654-10-W30/31
Mechanical straight joint

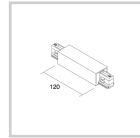

7653-10-W20/30/31
Central connector and straight joint

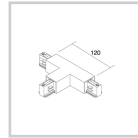

7656-10-W20/30/31
Right T joint

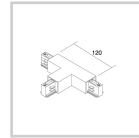

7656-11-W20/30/31
Left T joint

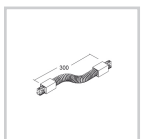

7658-10-W20/30/31
Flexible joint

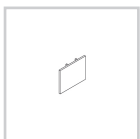

7659-00-W20/30/31
Dead end

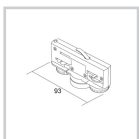

7600-00-20/30/31
Electro/mechanical adapter

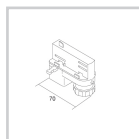

7601-00-W20/30/31
Mechanical/electrical adapter

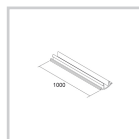

7624-00-30/31
Track cover

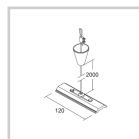

7606-05-30/31
Suspension kit

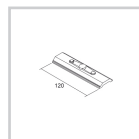

7606-04-00
Plate

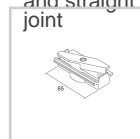

7625-00-30/31/52
Mechanical adapter

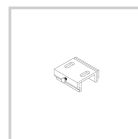

7607-00-00
Ceiling kit

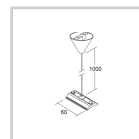

7626-00-00
Suspension kit

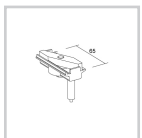

7618-00-30/31/52
Mechanical adapter with automatic locking

Pictures and Applications

SCHEMA ELETTRICO / WIRING DIAGRAMS

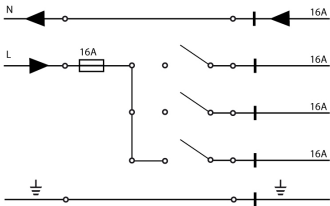

SCHEMA ELETTRICO / WIRING DIAGRAMS

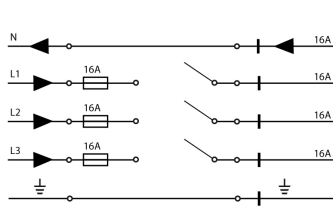

CAPACITÀ DI CARICO / LOAD CAPACITY

