

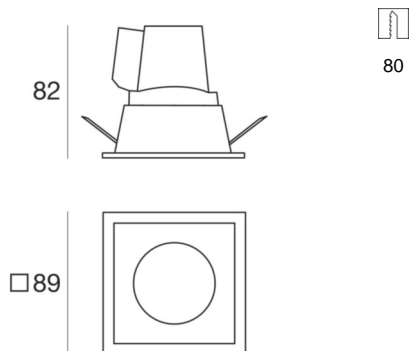

| 220-240 V | 1xGU10
8376



Technical data	
Installation position	Wall lights - Ceiling
Installation environment	Indoor
Lamp cap	1 x GU10 Max 42W
Frequency	50-60 Hz
Optics	spot
Light emission direction	downward
Safety class	1
IP	IP20
Glow wire test	850°
Direct mounting on normally flammable surfaces	Yes
CE	Yes
ETL	No
Fire Rated (BS 476 PT21 compliant)	No
Induction	No
Motion sensor	No
Directional	No
Tilting	No
Walk-over	No
Drive-over	No
Cable included	No
Resin potting	No

Finishing casing	
Material	Aluminium
Colour	black RAL 9005
Processing	Coating



| 220-240 V | 1xGU10
8376

Single emission for indoor application. Compatibility: LED lamp, halogen 42 W; lamp cap 1xGU10.

The device body is made of aluminium and features a black ral 9005 finish, processed by means of coating. The ingress protection degree is IP20;

The device features protection class I and can be wall lights or ceiling-mounted, with a 80 x 80 mm hole (in plasterboard).

Illuminotechnical Features

Source lumens	300 lm
Colour temperature	2800 K
Colour rendering index	100 Ra