

# PRODUCT FAMILY DATASHEET

## PARATHOM PAR16

LED reflector lamps PAR16 with retrofit pin base



---

### AREAS OF APPLICATION

- Shops
- Hospitality
- Museums, art galleries
- Residential interiors
- As a downlight for marking walkways, doors, stairs, etc.
- Spotlighting for accents
- Display cabinets and shop windows
- Spotlighting heat-sensitive objects such as food, plants, etc.
- Outdoor applications only in suitable luminaires

---

### PRODUCT BENEFITS

- Low energy consumption
- Easy replacement of halogen lamps due to compact full glass design and single optic
- Instant 100 % light, no warm-up time
- Ideal for economical spotlighting

---

### PRODUCT FEATURES

- Professional LED alternative to high voltage halogen lamps
- Mercury-free lamps
- Made in Germany



TECHNICAL DATA

Product description	Electrical data					Photometrical data			
	Nominal wattage	Nominal voltage	Claimed equiv. conventional lamp power	Max. lamp no. on circuit break. 10 A (B)	Max. lamp no. on circuit break. 16 A (B)	Nominal luminous flux	Rated luminous flux	Color temperature	Lumen main.fact.at end of nom.life time
P PAR 16 35 36° 3.3 W/2700K GU10 <sub>1)</sub>	3.30 W	220...240 V	35 W			230 lm	230 lm	2700 K	0.70
P PAR 16 35 36° 3.3 W/3000K GU10 <sub>1)</sub>	3.30 W	220...240 V	35 W			230 lm	230 lm	3000 K	0.70
P PAR 16 35 36° 3.3 W/4000K GU10 <sub>1)</sub>	3.30 W	220...240 V	35 W			230 lm	230 lm	4000 K	0.70
P PAR 16 50 36° 4.3 W/2700K GU10 <sub>1)</sub>	4.30 W	220...240 V	50 W	303	484	350 lm	350 lm	2700 K	0.70
P PAR 16 50 36° 4.3 W/3000K GU10 <sub>1)</sub>	4.30 W	220...240 V	50 W	303	484	350 lm	350 lm	3000 K	0.70
P PAR 16 50 36° 4.3 W/4000K GU10 <sub>1)</sub>	4.30 W	220...240 V	50 W	303	484	350 lm	350 lm	4000 K	0.70
P PAR 16 80 36° 6.9 W/2700K GU10 <sub>1)</sub>	6.90 W	220...240 V	80 W	59	97	575 lm	575 lm	2700 K	0.70
P PAR 16 80 36° 6.9 W/3000K GU10 <sub>1)</sub>	6.90 W	220...240 V	80 W	59	97	575 lm	575 lm	3000 K	0.70
P PAR 16 80 36° 6.9 W/4000K GU10 <sub>1)</sub>	6.90 W	220...240 V	80 W	59	97	575 lm	575 lm	4000 K	0.70
P PAR 16 80 60° 6.9 W/2700K GU10 <sub>1)</sub>	6.90 W	220...240 V	80 W			575 lm	575 lm	2700 K	0.70
P PAR 16 80 60° 6.9 W/3000K GU10 <sub>1)</sub>	6.90 W	220...240 V	80 W			575 lm	575 lm	3000 K	0.70
P PAR 16 80 60° 6.9 W/4000K GU10 <sub>1)</sub>	6.90 W	220...240 V	80 W			575 lm	575 lm	4000 K	0.70
P PAR16 100 36° 9.1 W/2700K GU10 <sub>1)</sub>	9.10 W	220...240 V	100 W			750 lm	750 lm	2700 K	0.70
P PAR16 100 36° 9.1 W/3000K GU10 <sub>1)</sub>	9.10 W	220...240 V	100 W			750 lm	750 lm	3000 K	0.70
P PAR16 100 36° 9.1 W/4000K GU10 <sub>1)</sub>	9.10 W	220...240 V	100 W			750 lm	750 lm	4000 K	0.70
P PAR 16 50 120° 4.3 W/2700K GU10 <sub>1)</sub>	4.30 W	220...240 V	50 W	303	484	350 lm	350 lm	2700 K	0.70
P PAR 16 50 120° 4.3 W/3000K GU10 <sub>1)</sub>	4.30 W	220...240 V	50 W	303	484	350 lm	350 lm	3000 K	0.70

Product description	Electrical data					Photometrical data			
	Nominal wattage	Nominal voltage	Claimed equiv. conventional lamp power	Max. lamp no. on circuit break. 10 A (B)	Max. lamp no. on circuit break. 16 A (B)	Nominal luminous flux	Rated luminous flux	Color temperature	Lumen main.fact.at end of nom.life time
P PAR 16 50 120° 4.3 W/4000K GU10 <sub>1)</sub>	4.30 W	220...240 V	50 W	303	484	350 lm	350 lm	4000 K	0.70
P PAR 16 80 120° 6.9 W/2700K GU10 <sub>1)</sub>	6.90 W	220...240 V	80 W	59	97	575 lm	575 lm	2700 K	0.70
P PAR 16 80 120° 6.9 W/3000K GU10 <sub>1)</sub>	6.90 W	220...240 V	80 W	59	97	575 lm	575 lm	3000 K	0.70
P PAR 16 80 120° 6.9 W/4000K GU10 <sub>1)</sub>	6.90 W	220...240 V	80 W	59	97	575 lm	575 lm	4000 K	0.70

Product description	Light color (designation)	Color temperature	Luminous flux	Color rendering index Ra	Luminous intensity [PIM]	Light technical data		Dimensions & weight		Temperatures & operating conditions
						Beam angle	Warm-up time (60 %)	Overall length	Diameter	Maximum temperature at tc test point
P PAR 16 35 36° 3.3 W/2700K GU10 <sub>1)</sub>	Warm White	2700 K	230 lm	≥80		36 °	< 0.50 s	55.0 mm	51.0 mm	70 °C
P PAR 16 35 36° 3.3 W/3000K GU10 <sub>1)</sub>	Warm White	3000 K	230 lm	≥80		36 °	< 0.50 s	55.0 mm	51.0 mm	70 °C
P PAR 16 35 36° 3.3 W/4000K GU10 <sub>1)</sub>	Warm White	4000 K	230 lm	≥80		36 °	< 0.50 s	55.0 mm	51.0 mm	70 °C
P PAR 16 50 36° 4.3 W/2700K GU10 <sub>1)</sub>	Warm White	2700 K	350 lm	≥80	850 cd	36 °	< 0.50 s	55.0 mm	51.0 mm	87 °C
P PAR 16 50 36° 4.3 W/3000K GU10 <sub>1)</sub>	Warm White	3000 K	350 lm	≥80	850 cd	36 °	< 0.50 s	55.0 mm	51.0 mm	87 °C
P PAR 16 50 36° 4.3 W/4000K GU10 <sub>1)</sub>	Cool White	4000 K	350 lm	≥80	850 cd	36 °	< 0.50 s	55.0 mm	51.0 mm	87 °C
P PAR 16 80 36° 6.9 W/2700K GU10 <sub>1)</sub>	Warm White	2700 K	575 lm	≥80	1164 cd	36 °	< 0.50 s	55.0 mm	51.0 mm	104 °C
P PAR 16 80 36° 6.9 W/3000K GU10 <sub>1)</sub>	Warm White	3000 K	575 lm	≥80	1439 cd	36 °	< 0.50 s	55.0 mm	51.0 mm	104 °C
P PAR 16 80 36° 6.9 W/4000K GU10 <sub>1)</sub>	Cool White	4000 K	575 lm	≥80	1439 cd	36 °	< 0.50 s	55.0 mm	51.0 mm	104 °C
P PAR 16 80 60° 6.9 W/2700K GU10 <sub>1)</sub>	Warm White	2700 K	575 lm	≥80		60 °	0.50 s	55.0 mm	51.0 mm	104 °C

Product description	Light color (designation)	Color temperature	Luminous flux	Color rendering index Ra	Luminous intensity [PIM]	Light technical data		Dimensions & weight		Temperatures & operating conditions
						Beam angle	Warm-up time (60 %)	Overall length	Diameter	Maximum temperature at tc test point
P PAR 16 80 60° 6.9 W/3000K GU10 <sub>1)</sub>	Warm White	3000 K	575 lm	≥80		60 °	< 0.50 s	55.0 mm	51.0 mm	104 °C
P PAR 16 80 60° 6.9 W/4000K GU10 <sub>1)</sub>	Cool White	4000 K	575 lm	≥80		60 °	< 0.50 s	55.0 mm	51.0 mm	104 °C
P PAR16 100 36° 9.1 W/2700K GU10 <sub>1)</sub>	Warm White	2700 K	750 lm	≥80		36 °	< 0.50 s	62.0 mm	51.0 mm	118 °C
P PAR16 100 36° 9.1 W/3000K GU10 <sub>1)</sub>	Warm White	3000 K	750 lm	≥80		36 °	< 0.50 s	62.0 mm	51.0 mm	118 °C
P PAR16 100 36° 9.1 W/4000K GU10 <sub>1)</sub>	Cool White	4000 K	750 lm	≥80		36 °	0.50 s	62.0 mm	51.0 mm	118 °C
P PAR 16 50 120° 4.3 W/2700K GU10 <sub>1)</sub>	Warm White	2700 K	350 lm	≥80	130 cd	120 °	< 0.50 s	55.0 mm	51.0 mm	87 °C
P PAR 16 50 120° 4.3 W/3000K GU10 <sub>1)</sub>	Warm White	3000 K	350 lm	≥80		120 °	< 0.50 s	55.0 mm	51.0 mm	87 °C
P PAR 16 50 120° 4.3 W/4000K GU10 <sub>1)</sub>	Cool White	4000 K	350 lm	≥80	130 cd	120 °	< 0.50 s	55.0 mm	51.0 mm	87 °C
P PAR 16 80 120° 6.9 W/2700K GU10 <sub>1)</sub>	Warm White	2700 K	575 lm	≥80	180 cd	120 °	< 0.50 s	55.0 mm	51.0 mm	104 °C
P PAR 16 80 120° 6.9 W/3000K GU10 <sub>1)</sub>	Warm White	3000 K	575 lm	≥80	180 cd	120 °	< 0.50 s	55.0 mm	51.0 mm	104 °C
P PAR 16 80 120° 6.9 W/4000K GU10 <sub>1)</sub>	Cool White	4000 K	575 lm	≥80	180 cd	120 °	< 0.50 s	55.0 mm	51.0 mm	104 °C

Product description	Lifespan		Additional product data			Capabilities	Certificates & standards	
	Nominal lamp life time	Number of switching cycles	Base (standard designation)	Mercury content	Mercury-free	Dimmable	Energy efficiency class	Energy consumption
P PAR 16 35 36° 3.3 W/2700K GU10 <sub>1)</sub>	15000 h	100000	GU10	0.0 mg	Yes	No	A+	4 kWh/1000h
P PAR 16 35 36° 3.3 W/3000K GU10 <sub>1)</sub>	15000 h	100000	GU10	0.0 mg	Yes	No	A+	4 kWh/1000h
P PAR 16 35 36° 3.3 W/4000K GU10 <sub>1)</sub>	15000 h	100000	GU10	0.0 mg	Yes	No	A+	4 kWh/1000h

Product description	Lifespan		Additional product data			Capabilities	Certificates & standards	
	Nominal lamp life time	Number of switching cycles	Base (standard designation)	Mercury content	Mercury-free	Dimmable	Energy efficiency class	Energy consumption
P PAR 16 50 36° 4.3 W/2700K GU10 <sub>1)</sub>	10000 h	100000	GU10	0.0 mg	Yes	No	A+	5 kWh/1000h
P PAR 16 50 36° 4.3 W/3000K GU10 <sub>1)</sub>	15000 h	100000	GU10	0.0 mg	Yes	No	A+	5 kWh/1000h
P PAR 16 50 36° 4.3 W/4000K GU10 <sub>1)</sub>	15000 h	100000	GU10	0.0 mg	Yes	No	A+	5 kWh/1000h
P PAR 16 80 36° 6.9 W/2700K GU10 <sub>1)</sub>	15000 h	100000	GU10	0.0 mg	Yes	No	A+	7 kWh/1000h
P PAR 16 80 36° 6.9 W/3000K GU10 <sub>1)</sub>	15000 h	100000	GU10	0.0 mg	Yes	No	A+	7 kWh/1000h
P PAR 16 80 36° 6.9 W/4000K GU10 <sub>1)</sub>	15000 h	100000	GU10	0.0 mg	Yes	No	A+	7 kWh/1000h
P PAR 16 80 60° 6.9 W/2700K GU10 <sub>1)</sub>	15000 h	100000	GU10	0.0 mg	Yes	No	A+	7 kWh/1000h
P PAR 16 80 60° 6.9 W/3000K GU10 <sub>1)</sub>	15000 h	100000	GU10	0.0 mg	Yes	No	A+	7 kWh/1000h
P PAR 16 80 60° 6.9 W/4000K GU10 <sub>1)</sub>	15000 h	100000	GU10	0.0 mg	Yes	No	A+	7 kWh/1000h
P PAR16 100 36° 9.1 W/2700K GU10 <sub>1)</sub>	15000 h	100000	GU10	0.0 mg	Yes	No	A+	10 kWh/1000h
P PAR16 100 36° 9.1 W/3000K GU10 <sub>1)</sub>	15000 h	100000	GU10	0.0 mg	Yes	No	A+	10 kWh/1000h
P PAR16 100 36° 9.1 W/4000K GU10 <sub>1)</sub>	15000 h	100000	GU10	0.0 mg	Yes	No	A+	10 kWh/1000h
P PAR 16 50 120° 4.3 W/2700K GU10 <sub>1)</sub>	15000 h	100000	GU10	0.0 mg	Yes	No	A+	5 kWh/1000h
P PAR 16 50 120° 4.3 W/3000K GU10 <sub>1)</sub>	15000 h	100000	GU10	0.0 mg	Yes	No	A+	5 kWh/1000h
P PAR 16 50 120° 4.3 W/4000K GU10 <sub>1)</sub>	15000 h	100000	GU10	0.0 mg	Yes	No	A+	5 kWh/1000h
P PAR 16 80 120° 6.9 W/2700K GU10 <sub>1)</sub>	15000 h	100000	GU10	0.0 mg	Yes	No	A+	7 kWh/1000h
P PAR 16 80 120° 6.9 W/3000K GU10 <sub>1)</sub>	15000 h	100000	GU10	0.0 mg	Yes	No	A+	7 kWh/1000h
P PAR 16 80 120° 6.9 W/4000K GU10 <sub>1)</sub>	15000 h	100000	GU10	0.0 mg	Yes	No	A+	7 kWh/1000h

Product description	Country-specific categorizations	
	ILCOS	
P PAR 16 35 36° 3.3 W/2700K GU10 1)		
P PAR 16 35 36° 3.3 W/3000K GU10 1)		
P PAR 16 35 36° 3.3 W/4000K GU10 1)		
P PAR 16 50 36° 4.3 W/2700K GU10 1)	DRPAR-4,3/827-220-240-GU10-50/36	
P PAR 16 50 36° 4.3 W/3000K GU10 1)	DRPAR-4,3/830-220-240-GU10-50/36	
P PAR 16 50 36° 4.3 W/4000K GU10 1)	DRPAR-4,3/840-220-240-GU10-50/36	
P PAR 16 80 36° 6.9 W/2700K GU10 1)	DRPAR-6,9/827-220-240-GU10-50/36	
P PAR 16 80 36° 6.9 W/3000K GU10 1)	DRPAR-6,9/830-220-240-GU10-50/36	
P PAR 16 80 36° 6.9 W/4000K GU10 1)	DRPAR-6,9/840-220-240-GU10-50/36	
P PAR 16 80 60° 6.9 W/2700K GU10 1)		
P PAR 16 80 60° 6.9 W/3000K GU10 1)		
P PAR 16 80 60° 6.9 W/4000K GU10 1)		
P PAR16 100 36° 9.1 W/2700K GU10 1)		
P PAR16 100 36° 9.1 W/3000K GU10 1)		
P PAR16 100 36° 9.1 W/4000K GU10 1)		
P PAR 16 50 120° 4.3 W/2700K GU10 1)	DRPAR-4,3/827-220-240-GU10-50/36	
P PAR 16 50 120° 4.3 W/3000K GU10 1)		
P PAR 16 50 120° 4.3 W/4000K GU10 1)	DRPAR-4,3/840-220-240-GU10-50/36	
P PAR 16 80 120° 6.9 W/2700K GU10 1)	DRPAR-6,9/827-220-240-GU10-50/120	

Country-specific categorizations	
Product description	ILCOS
P PAR 16 80 120° 6.9 W/3000K GU10 1)	DRPAR-6,9/830-220-240-GU10-50/120
P PAR 16 80 120° 6.9 W/4000K GU10 1)	DRPAR-6,9/840-220-240-GU10-50/120

<sup>1)</sup> All technical parameters apply to the entire lamp/Due to the complex production process for light-emitting diodes, the typical values shown for the technical LED parameters are purely statistical values that do not necessarily match the actual technical parameters of each individual product, which can vary from the typical value

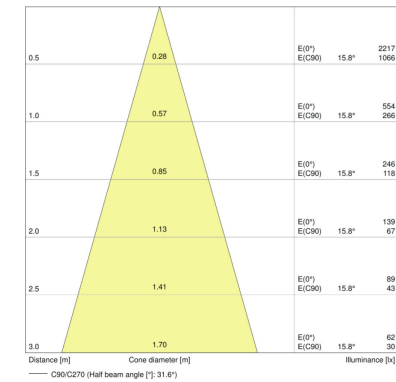
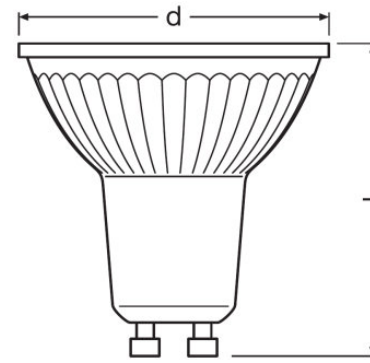
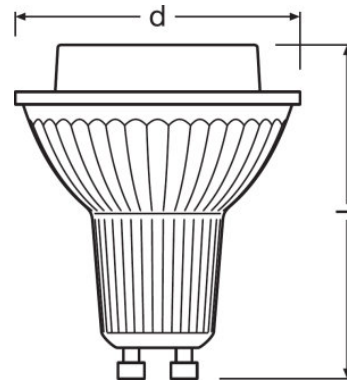
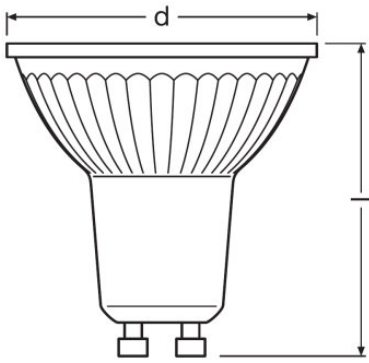

P PAR 16 35 36° 3.3 W/2700K GU10, P  
 PAR 16 35 36° 3.3 W/3000K GU10, P  
 PAR 16 35 36° 3.3 W/4000K GU10, P  
 PAR 16 50 36° 4.3 W/2700K GU10, P  
 PAR 16 50 36° 4.3 W/3000K GU10, P  
 PAR 16 50 36° 4.3 W/4000K GU10, P  
 PAR 16 80 36° 6.9 W/2700K GU10, P  
 PAR 16 80 36° 6.9 W/3000K GU10, P  
 PAR 16 80 36° 6.9 W/4000K GU10, P  
 PAR 16 80 60° 6.9 W/2700K GU10, P  
 PAR 16 80 60° 6.9 W/3000K GU10, P  
 PAR 16 80 60° 6.9 W/4000K GU10, P  
 PAR 16 50 120° 4.3 W/2700K GU10, P  
 PAR 16 50 120° 4.3 W/3000K GU10, P  
 PAR 16 80 120° 6.9 W/2700K GU10, P  
 PAR 16 80 120° 6.9 W/3000K GU10, P  
 PAR 16 80 120° 6.9 W/4000K GU10

P PAR16 100 36° 9.1 W/2700K GU10, P  
 PAR16 100 36° 9.1 W/3000K GU10, P  
 PAR16 100 36° 9.1 W/4000K GU10

P PAR 16 50 120° 4.3 W/4000K GU10

P PAR 16 35 36° 3.3 W/2700K GU10



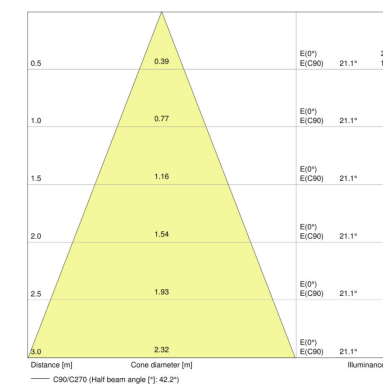
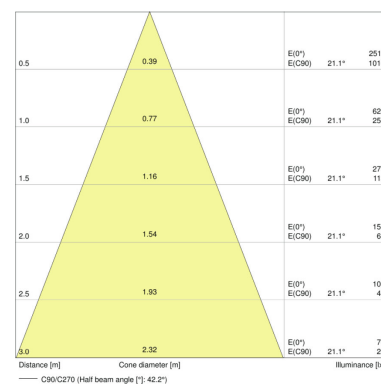
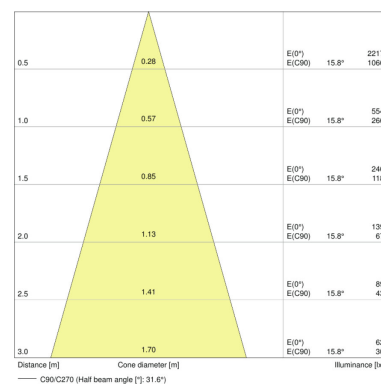
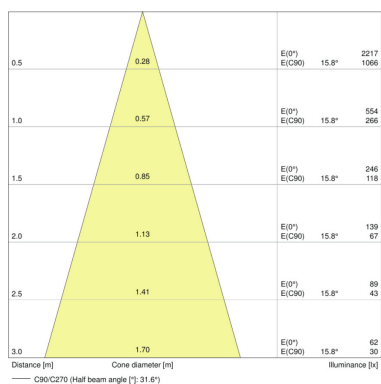

P PAR 16 35 36° 3.3 W/3000K GU10

P PAR 16 35 36° 3.3 W/4000K GU10

P PAR 16 50 36° 4.3 W/2700K GU10

P PAR 16 50 36° 4.3 W/3000K GU10

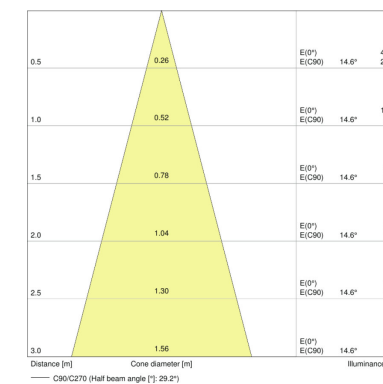
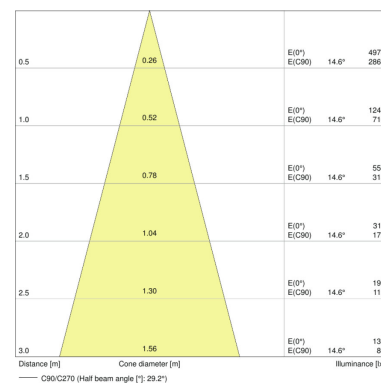
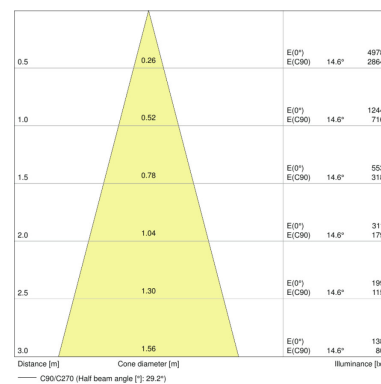
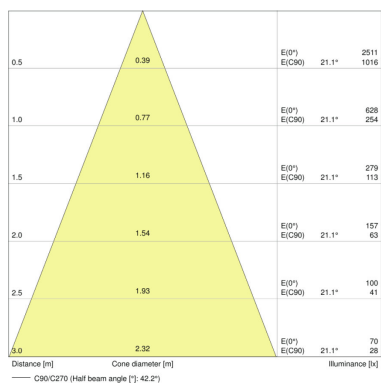

P PAR 16 50 36° 4.3 W/4000K GU10

P PAR 16 80 36° 6.9 W/2700K GU10

P PAR 16 80 36° 6.9 W/3000K GU10

P PAR 16 80 36° 6.9 W/4000K GU10

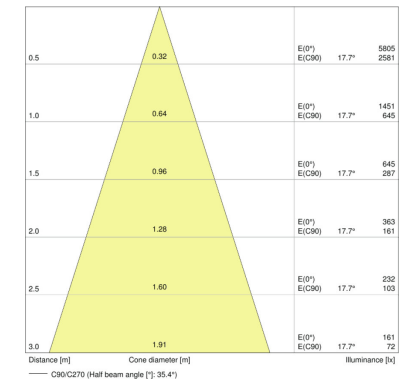
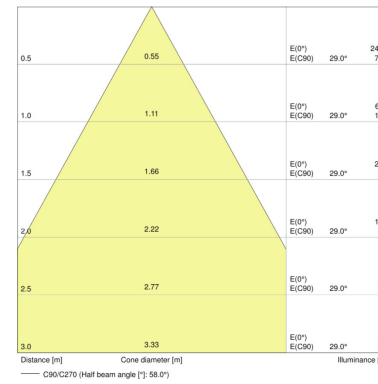
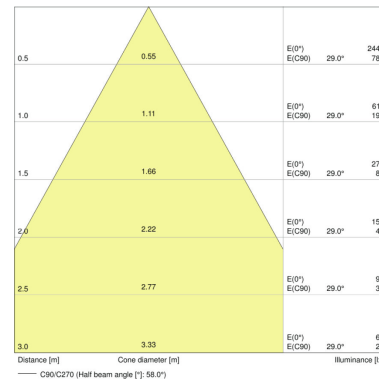
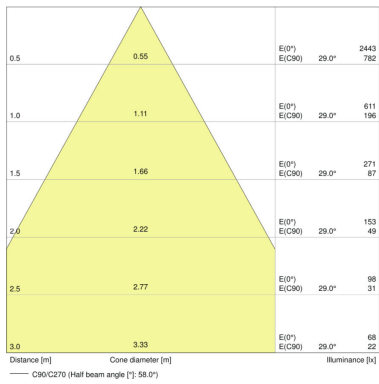

P PAR 16 80 60° 6.9 W/2700K GU10

P PAR 16 80 60° 6.9 W/3000K GU10

P PAR 16 80 60° 6.9 W/4000K GU10

P PAR16 100 36° 9.1 W/2700K GU10

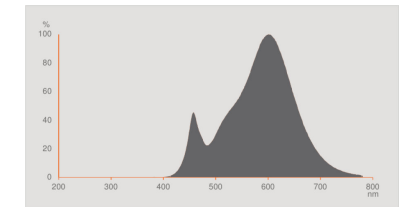
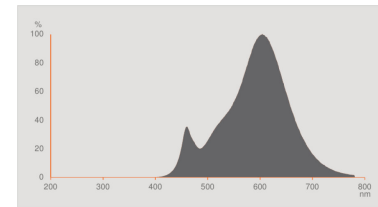
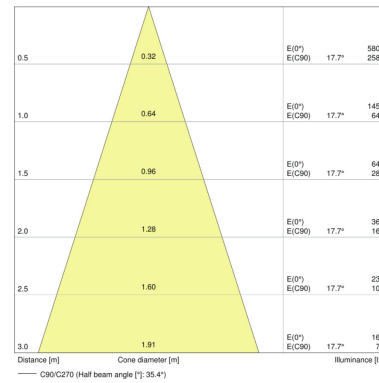
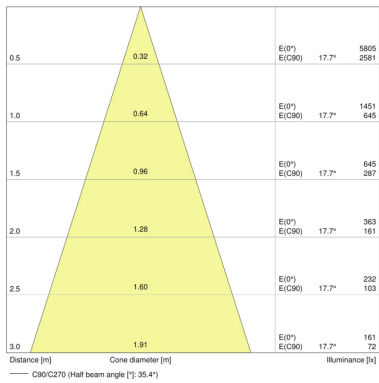

P PAR16 100 36° 9.1 W/3000K GU10

P PAR16 100 36° 9.1 W/4000K GU10

P PAR 16 50 120° 4.3 W/2700K GU10

P PAR 16 50 120° 4.3 W/3000K GU10

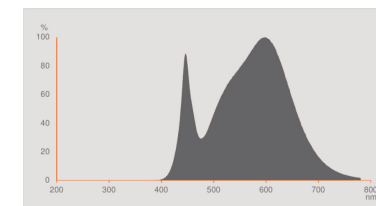
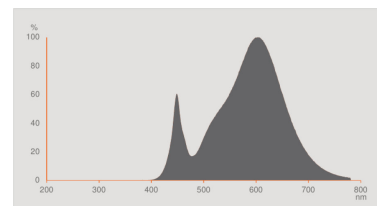
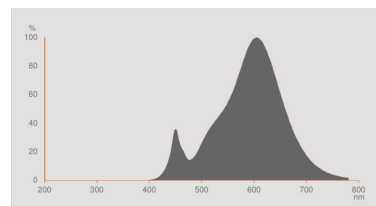
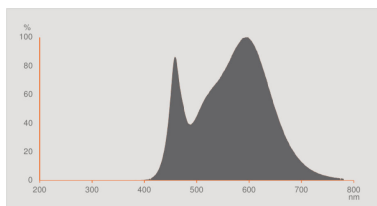

P PAR 16 50 120° 4.3 W/4000K GU10

P PAR 16 80 120° 6.9 W/2700K GU10

P PAR 16 80 120° 6.9 W/3000K GU10

P PAR 16 80 120° 6.9 W/4000K GU10

**APPLICATION ADVICE**

For more detailed application information and graphics please see product datasheet.

**LOGISTICAL DATA**

Product code	Packaging unit (Pieces/Unit)	Dimensions (length x width x height)	Gross weight	Volume
4058075132207	Shipping carton box 10	257 mm x 110 mm x 70 mm	548.00 g	1.98 dm <sup>3</sup>
4058075132184	Shipping carton box 10	257 mm x 110 mm x 70 mm	548.00 g	1.98 dm <sup>3</sup>
4058075132160	Shipping carton box 10	257 mm x 110 mm x 70 mm	548.00 g	1.98 dm <sup>3</sup>
4052899958807	Shipping carton box 10	257 mm x 110 mm x 70 mm	570.00 g	1.98 dm <sup>3</sup>
4052899451742	Shipping carton box 10	257 mm x 110 mm x 70 mm	549.00 g	1.98 dm <sup>3</sup>

Product code	Packaging unit (Pieces/Unit)	Dimensions (length x width x height)	Gross weight	Volume
4052899958821	Shipping carton box 10	257 mm x 110 mm x 70 mm	578.00 g	1.98 dm <sup>3</sup>
4052899958876	Shipping carton box 10	257 mm x 110 mm x 70 mm	598.00 g	1.98 dm <sup>3</sup>
4058075815667	Shipping carton box 10	257 mm x 110 mm x 70 mm	595.00 g	1.98 dm <sup>3</sup>
4052899958883	Shipping carton box 10	257 mm x 110 mm x 70 mm	566.00 g	1.98 dm <sup>3</sup>
4058075096493	Shipping carton box 10	257 mm x 110 mm x 70 mm	598.00 g	1.98 dm <sup>3</sup>
4058075096479	Shipping carton box 10	257 mm x 110 mm x 70 mm	598.00 g	1.98 dm <sup>3</sup>
4058075096455	Shipping carton box 10	257 mm x 110 mm x 70 mm	598.00 g	1.98 dm <sup>3</sup>
4058075096592	Shipping carton box 10	255 mm x 107 mm x 72 mm	900.00 g	1.96 dm <sup>3</sup>
4058075096530	Shipping carton box 10	255 mm x 107 mm x 72 mm	900.00 g	1.96 dm <sup>3</sup>
4058075096516	Shipping carton box 10	255 mm x 107 mm x 72 mm	900.00 g	1.96 dm <sup>3</sup>
4052899958814	Shipping carton box 10	257 mm x 110 mm x 70 mm	544.00 g	1.98 dm <sup>3</sup>
4058075023482	Shipping carton box 10	257 mm x 110 mm x 70 mm	550.00 g	1.98 dm <sup>3</sup>
4052899958845	Shipping carton box 10	257 mm x 110 mm x 70 mm	570.00 g	1.98 dm <sup>3</sup>
4058075815889	Shipping carton box 10	257 mm x 110 mm x 70 mm	564.00 g	1.98 dm <sup>3</sup>
4058075815643	Shipping carton box 10	257 mm x 110 mm x 70 mm	587.00 g	1.98 dm <sup>3</sup>
4058075815681	Shipping carton box 10	257 mm x 110 mm x 70 mm	590.00 g	1.98 dm <sup>3</sup>

Product code	Packaging unit (Pieces/Unit)	Dimensions (length x width x height)	Gross weight	Volume
--------------	------------------------------	--------------------------------------	--------------	--------

The mentioned product code describes the smallest quantity unit which can be ordered. One shipping unit can contain one or more single products. When placing an order, for the quantity please enter single or multiples of a shipping unit.

---

#### REFERENCES / LINKS

For further products and actual information concerning LED lamps see

- ▶ [www.ledvance.com/ledlamps](http://www.ledvance.com/ledlamps)

For Guarantee see

- ▶ [www.ledvance.com/guarantee](http://www.ledvance.com/guarantee)

---

#### DISCLAIMER

Subject to change without notice. Errors and omission excepted. Always make sure to use the most recent release.