

► **Termostato elettronico estate/inverno**

*Electronic summer/winter thermostat*

*Thermostat électronique été/hiver*

*Termostato electrónico verano/invierno*

*Elektronischer thermostat sommer/winter*

*Termostat electronic vară/iarnă*

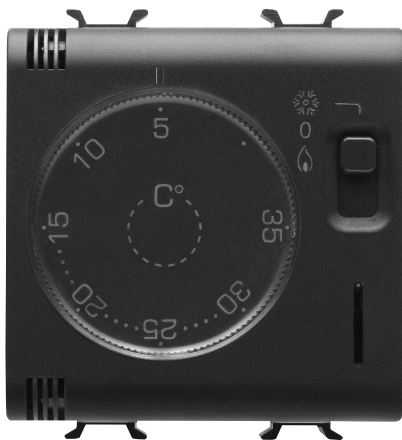

**GW10705**

**GW12705**

**GW11705**

**GW14705**

## ► **Attenzione - Importante**

**Attenzione !** La sicurezza dell'apparecchio è garantita solo attenendosi alle istruzioni qui riportate. Pertanto è necessario leggerle e conservarle.

I prodotti Chorus devono essere installati conformemente a quanto previsto dalla norma CEI 64-8 per gli apparecchi per uso domestico e similare, in ambienti non polverosi e dove non sia necessaria una protezione speciale contro la penetrazione di acqua.

L'organizzazione di vendita GEWISS é a disposizione per chiarimenti e informazioni tecniche.

<b>GENERALITÀ PRODOTTO</b>	<i>pag.</i>
- Funzioni .....	4
<b>ISTRUZIONI D'INSTALLAZIONE</b>	
- Logica applicativa .....	5
- Collegamenti elettrici.....	7
<b>ISTRUZIONI D'IMPIEGO</b>	
- Comandi e segnalazioni.....	8

## Funzioni

### DATI PRESTAZIONALI

---

Funzione estate / inverno.

Segnalazioni luminose:

- Led giallo funzione di localizzazione.
- Led verde indicazione stato uscita (accesso contatto NA chiuso).

### DATI TECNICI

---

Tensione di alimentazione:	230 V~ 50÷60 Hz
Potenza assorbita:	2VA
Tipo di uscita:	a relé con contatto in scambio NA/COM/NC 8 A / 250 V~
Collegamenti utenza (carico):	2 o 3 conduttori
Sezione massima dei fili ai morsetti:	2,5 mm <sup>2</sup>
Tipo di isolamento:	Classe II 
Grado di protezione:	IP 30
Polluzione:	Normale
Campo di regolazione:	da +5°C a +35°C
Differenziale termico:	1°C
Limiti della temperatura di funzionamento:	0°C ÷ +50°C
Normative di riferimento per marcatura CE:	
EMC EN55014-1 EN55014-2 EN61000-3-2 EN61000-3-3	
LVD EN60730-1 EN60730-2-9	
(Direttive 2006/95/CE - 2004/108/CE)	

## Logica applicativa

OK

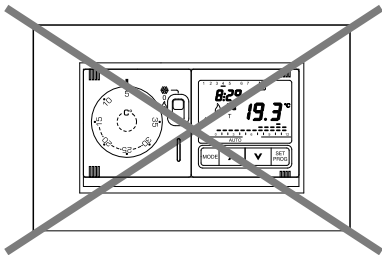
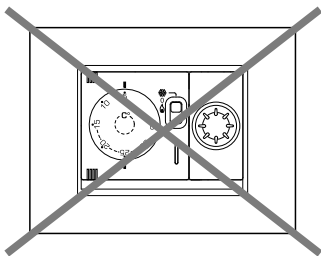
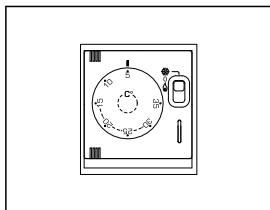

# ISTRUZIONI D'INSTALLAZIONE

## Logica applicativa

### Consigli sul posizionamento:

Installare il termostato a quota 1,50÷1,70 m dal pavimento, lontano da sorgenti di calore, prese d'aria, porte o finestre. Non installare su pareti perimetrali.

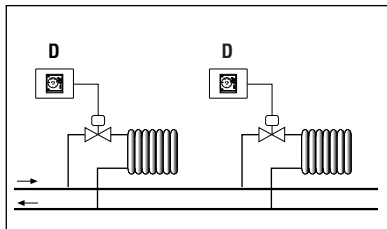
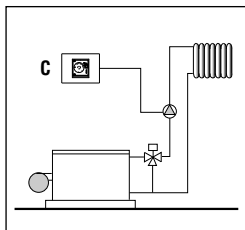
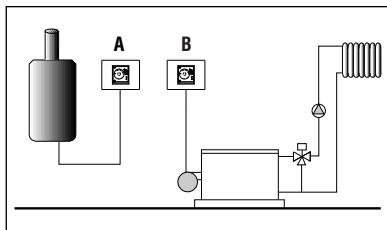
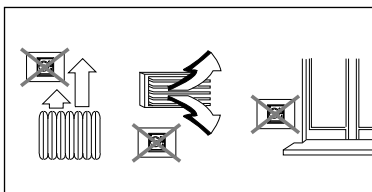
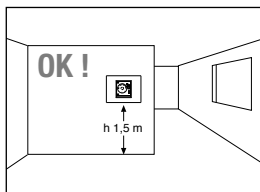

Impianti di riscaldamento con termostato che comanda:

**A** Caldaia murale

**B** Bruciatore

**C** Pompa di circolazione

**D** Elettrovalvola di zona

**N.B.:** Gli esempi riportati nella seguente documentazione sono di principio

## Collegamenti elettrici

**Importante:** l'installazione ed il collegamento elettrico dei dispositivi ed apparecchiature devono essere eseguiti da personale qualificato ed in conformità alle norme e leggi vigenti. Il costruttore non si assume nessuna responsabilità per quanto concerne l'impiego di prodotti che debbano seguire particolari norme di ambienti e/o installazione, il cui onere resta di competenza ed a carico dell'installatore.

**Attenzione:** prima di effettuare l'installazione del prodotto, disattivare la tensione di rete.

Con disattivata la tensione di rete:

Collegare i fili di alimentazione ai morsetti n° L (Linea) e n° N (Neutro).

Collegare i fili del dispositivo da comandare ai morsetti: n° 1 = contatto NA

n° 2 = comune

n° 3 = contatto NC

Con forti carichi induttivi (pompe ed elettrovalvole) si consiglia di collegare un filtro RC in parallelo al carico.

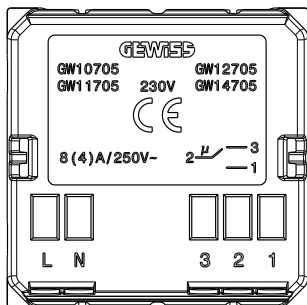

### Morsetti di cablaggio

Alimentazione: L - Fase  
N - Neutro

Relè di uscita: 1 - Contatto NA  
2 - Comune  
3 - Contatto NC

# ISTRUZIONI D'IMPIEGO

## Comandi e segnalazioni

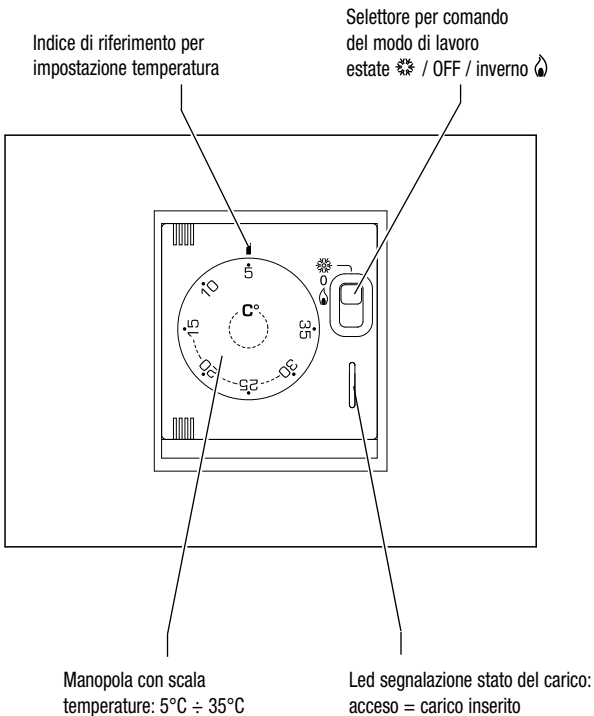



**E N G L I S H**

**Electronic summer/winter thermostat**

## ▶ **Attention - Important**

**Warning !** The safety of this appliance is only guaranteed if all the instructions given here are followed scrupulously.

These should be read thoroughly and kept in a safe place.

Chorus products can be installed in environments which are dust-free and where no special protection against the penetration of water is required. They shall be installed in compliance with the requirements for household devices set out by the national standards and rules applicable to low-voltage electrical installations which are in force in the country where the products are installed, or, when there are none, following the international standard for low-voltage electrical installations IEC 60364, or the European harmonization document HD 60364. Gewiss sales organization is ready to provide full explanations and technical data on request.

<b>GENERAL PRODUCT DESCRIPTION</b>	<i>page</i>
- Functions .....	12
<b>INSTALLATION INSTRUCTIONS</b>	
- Location advice .....	13
- Electrical connections.....	15
<b>OPERATING INSTRUCTIONS</b>	
- Commands and signals .....	16

# GENERAL PRODUCT DESCRIPTION

## Functions

### PERFORMANCE DATA

---

Function summer / winter.

Luminous signals:

- Yellow localisation function LED.
- Green output status indicator LED (NA contact access closed).

### TECHNICAL SPECIFICATIONS

---

Power supply:	230 V~ 50÷60 Hz
Power absorbed:	2VA
Type of relay output:	with exchange contact NA/COM/NC 8 A / 250 V~
User connections (load):	2 or 3 wires
Max. wire section at the terminals:	2,5 mm <sup>2</sup>
Type of insulation:	Class II 
Grade of protection:	IP 30
Pollution:	Normal
Regulation range:	from +5°C to +35°C
Hysteresis:	1°C
Temperature operating limits:	0°C ÷ +50°C
Reference standards for CE marking:	
EMC EN55014-1 EN55014-2 EN61000-3-2 EN61000-3-3	
LVD EN60730-1 EN60730-2-9	
(Directive 2006/95/EC - 2004/108/EC)	

# INSTALLATION INSTRUCTIONS

## Location advice

OK

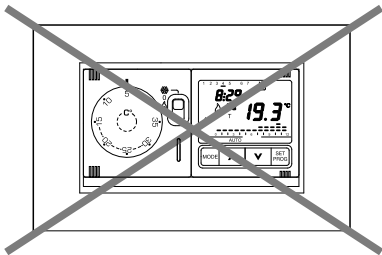
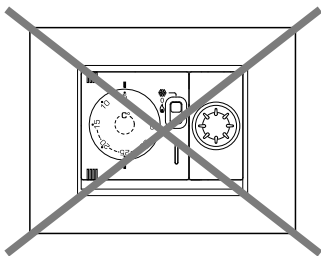
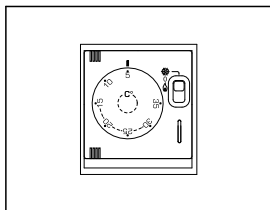

# INSTALLATION INSTRUCTIONS

## Location advice

### Recommendations for positioning:

Install the thermostat at a height of approx. 1.50÷1.70 m from floor level, away from heat sources, draughts, doors and windows. Do not install on perimeter walls.

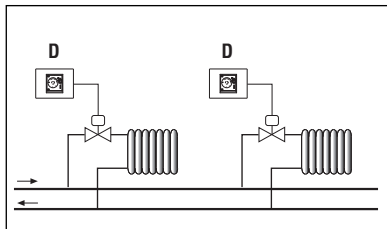
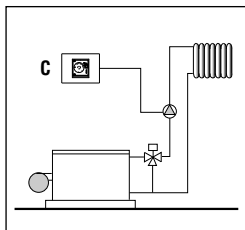
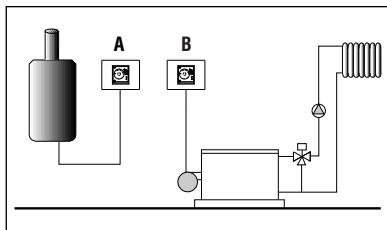
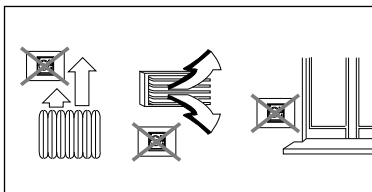
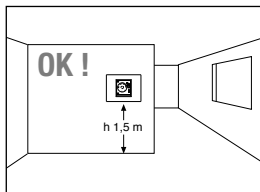

Heating systems with thermostat controlling:  
**A** Wall mounted boiler  
**B** Burner  
**C** Circulation pump  
**D** Zone solenoid valve

**N.B.:** The examples given in the following documentation are for illustrative purposes only.

# INSTALLATION INSTRUCTIONS

## Electrical connections

**Important:** the installation and electrical connecting of the devices and appliances must be undertaken by qualified personnel and in accordance with standards and regulations in force at the time. The manufacture declines to accept any responsibility concerning the use of the products in accordance with particular environmental or installation regulations, as this responsibility rests entirely with the installer.

**Warning:** Prior to installing the product, ensure the mains electrical supply is disconnected.

With the mains power supply disconnected:

Connect the power supply wires to terminals:

n° L (Line) and n° N (Neutral).

Connect the wires of the device to be controlled to terminals:

n° 1 = NA contact

n° 2 = common

n° 3 = NC contact

With strong inductive loads (pumps and solenoid valves) it is recommended that an RC filter is connected in parallel to the load.

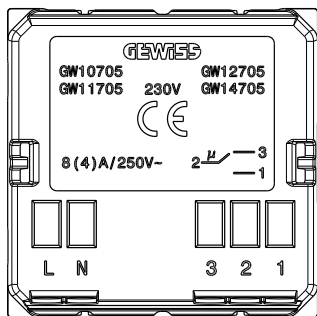

### Cabling terminals

Power supply : L - Phase  
N - Neutral

Output relay: 1 = NA contact  
2 = common  
3 = NC contact

# OPERATING INSTRUCTIONS

## Commands and signal

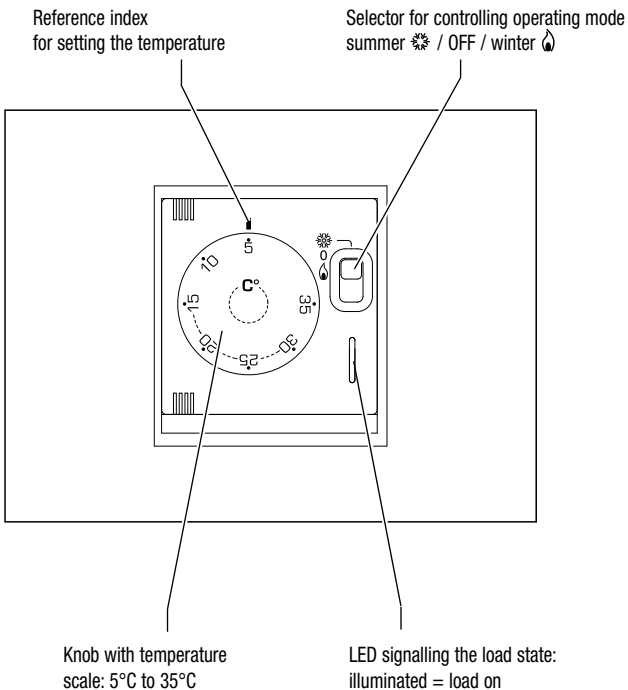



**F R A N Ç A I S**

**Thermostat électrique été/hiver**

## ► **Attention - Important**

**Attention !** La sécurité de cet appareil n'est garantie que si toutes les instructions données ici sont suivies scrupuleusement.

Il convient de les lire attentivement et de les conserver en lieu sûr.

Les produits de la série Chorus peuvent être installés dans un environnement exempt de poussière et où aucune protection spéciale contre la pénétration d'eau n'est nécessaire. Ils doivent être installés en conformité avec les exigences relatives aux appareils à usages domestiques et analogues prévues par les normes et règles nationales applicables aux installations électriques à basse tension en vigueur dans le pays où les produits sont installés, ou, en leur absence, en respectant la norme internationale relative aux installations électriques à basse tension CEI 60364, ou le document d'harmonisation européen HD 60364.

Le réseau de vente de Gewiss est prêt à fournir des explications complètes et des données techniques sur demande.

# SOMMAIRE

<b>GENERALITES SUR LE PRODUIT</b>	<i>page</i>
- Fonctions .....	20
<b>INSTRUCTIONS POUR L'INSTALLATION</b>	
- Logique d'application .....	21
- Raccordements électriques .....	23
<b>INSTRUCTIONS POUR L'EMPLOI</b>	
- Commandes et signalisations .....	24

## Fonctions

### DONNEES SUR LES PERFORMANCES DE L'APPAREIL

---

Fonction été / hiver.

Voyants lumineux :

- Led jaune fonction de localisation.
- Led verte indication état de sortie (accès contact NO fermé).

### DONNEES TECHNIQUES

---

Tension d'alimentation :	230 V~ 50÷60 Hz
Puissance absorbée :	2VA
Type de sortie :	à relais avec contact en échange NO/COMM/NF 8 A / 250 V~
Raccordement appareil (charge) :	2 ou 3 conducteurs
Section maximum des fils aux borniers :	2,5 mm <sup>2</sup>
Type d'isolement :	Classe II 
Degré de protection :	IP 30
Pollution :	Normale
Plage de réglages :	de +5°C au +35°C
Hystérésis :	1°C
Limites de la température de fonctionnement :	0°C ÷ +50°C
Réglémentations de référence pour marque CE :	
EMC EN55014-1 EN55014-2 EN61000-3-2 EN61000-3-3	
LVD EN60730-1 EN60730-2-9	
(Directives 2006/95/CE - 2004/108/CE)	

# INSTRUCTIONS POUR L'INSTALLATION



## Logique d'application

OK

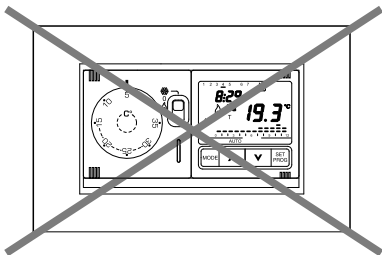
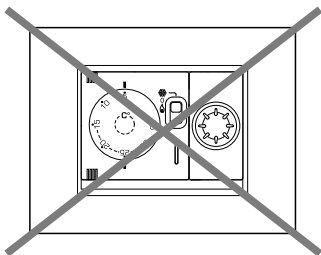
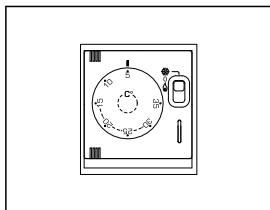

# INSTRUCTIONS POUR L'INSTALLATION

## Logique d'application

### Conseils pour le positionnement :

Installer le thermostat à une hauteur de 1,50÷1,70 m du sol, loin des sources de chaleur, des prises d'air, des portes ou des fenêtres. Ne pas installer sur murs périphériques.

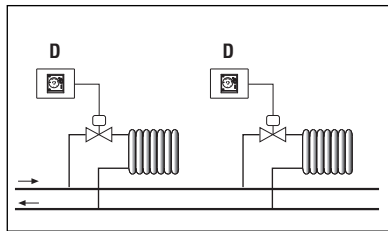
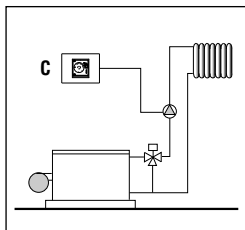
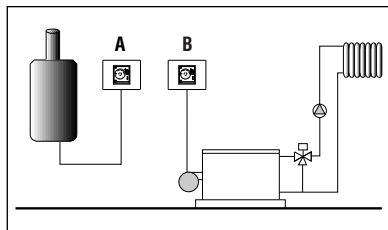
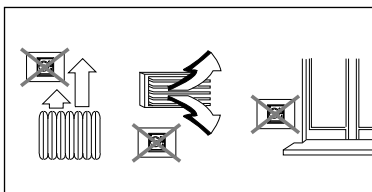
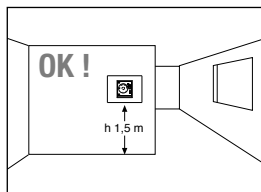

Installations de chauffage avec thermostat commandant :

- A Chaudière murale
- B Brûleur
- C Pompe de circulation
- D Electrovanne de zone

**N.B.:** Les exemples donnés dans la documentation suivante sont des exemples de principe.

# INSTRUCTIONS POUR L'INSTALLATION

## Raccordements électriques

**Important** : l'installation et le raccordement électrique des dispositifs et des appareils doivent être effectués par des personnes qualifiées et conformément aux normes et aux lois en vigueur. Le constructeur ne répondra aucunement en cas d'utilisation de produits ne respectant pas certaines normes du milieu ambiant et/ou d'installation, qui relèvent des compétences de l'installateur et sont entièrement à sa charge .

**Attention** : avant de procéder à l'installation de l'appareil, mettre hors tension.

Quand on a coupé le courant :

Connecter les fils d'alimentation aux bornes

n° L (Ligne) et n° N (Neutre).

Connecter les fils du dispositif à commander aux bornes: n° 1 = contact NO

n° 2 = commun

n° 3 = contact NF

En cas de fortes charges inductives (pompes et électrovannes) on conseille de relier un filtre RC en parallèle à la charge .

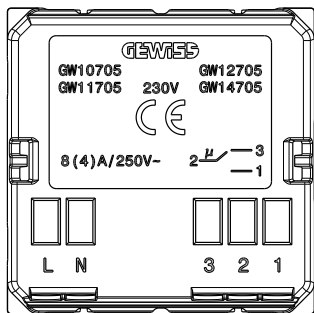

### Bornes de câblage

Alimentation : L - Phase  
N - Neutre

Relais de sortie: 1 = contact NO  
2 = commun  
3 = contact NF

# INSTRUCTIONS POUR L'EMPLOI



## Commandes et signalisations

Index de repère  
pour programmation  
de la température

Sélecteur pour commande  
du mode de service  
été ☀ / OFF / hiver 🔥

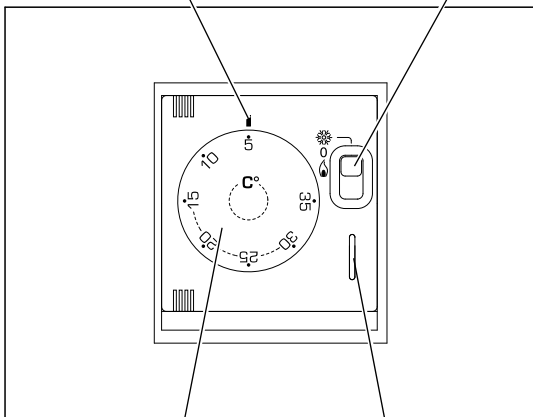

Bouton avec échelle  
des températures :  
5°C ÷ 35°C

Diode de signalisation  
de l'état de la charge :  
allumée = charge activée



**E S P A Ñ O L**

**Termostato electrónico verano/invierno**

## ► **Atención - Importante**

**Atención !** La seguridad de este aparato está garantizada solamente si se respetan meticulosamente todas las instrucciones aquí presentadas.

Cabe leer detenidamente estas instrucciones y guardarlas en un sitio seguro.

Los productos de la serie Chorus se pueden instalar en emplazamientos libres de polvo y donde no se exija una protección especial contra la penetración de agua.

Ellos tienen que ser instalados en conformidad con los requisitos para los aparatos para uso doméstico dictados por las normas y los reglamentos nacionales aplicables a las instalaciones eléctricas de baja tensión vigentes en el país donde se instalan los productos, o, si en dicho país no existen normas, en conformidad con la norma internacional para instalaciones eléctricas de baja tensión CEI 60364 o a la norma europea armonizada HD 60364.

La organización de ventas de Gewiss está a disposición para proporcionar aclaraciones y datos técnicos si se solicitan.

<b>DESCRIPCIÓN GENERAL DEL PRODUCTO</b>	<i>pág.</i>
- Funciones.....	28
<b>INSTRUCCIONES PARA LA INSTALACIÓN</b>	
- Lógica aplicativa .....	29
- Conexión eléctricas .....	31
<b>INSTRUCCIONES PARA EL EMPLEO</b>	
- Mandos y señalizaciones .....	32

# DESCRIPCIÓN GENERAL DEL PRODUCTO

## Funciones

### DATOS DE LAS PRESTACIONES

---

Función verano / invierno.

Señalizaciones luminosas:

- Led amarillo función de localización.
- Led verde indicación estado salida (acceso contacto NA cerrado).

### DATOS TÉCNICOS

---

Tensión de alimentación:	230 V~ 50÷60 Hz
Potencia absorbible:	2VA
Tipo de salida:	mediante relé con contacto NA/CON/NC 8 A / 250 V~
Conexiones usuario (carga):	2 o 3 conductores
Sección máxima de los hilos en los bornes:	2,5 mm <sup>2</sup>
Tipo de aislamiento:	Clase II 
Grado de protección:	IP 30
Polución:	Normal
Campo de regulación:	de +5°C a +35°C
Diferencial térmico:	1°C
Límites de la temperatura de funcionamiento:	0°C ÷ +50°C
Normas de referencia para marca CE:	
EMC EN55014-1 EN55014-2 EN61000-3-2 EN61000-3-3	
LVD EN60730-1 EN60730-2-9	
(Directrices 2006/95/CE - 2004/108/CE)	

# INSTRUCCIONES PARA LA INSTALACIÓN

## Logica applicativa

OK

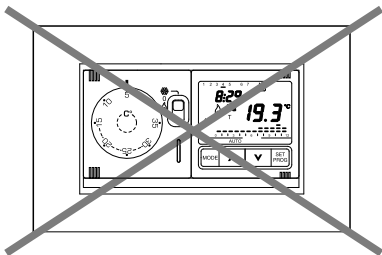
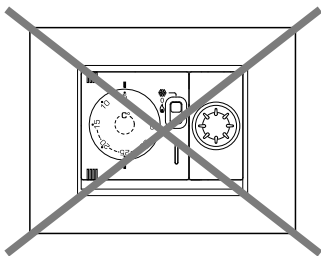
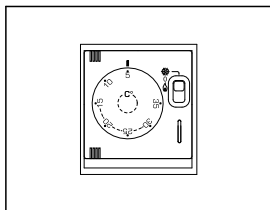

# INSTRUCCIONES PARA LA INSTALACIÓN

## Logica aplicada

### Consejos para la colocación:

Instalar el termostato en cota  $1,50 \pm 1,70$  m desde el suelo, lejos de fuentes de calor, tomas de aire, puertas o ventanas. No instalar en paredes perimétricas.

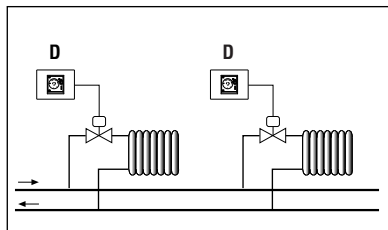
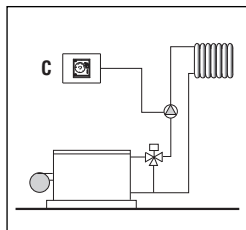
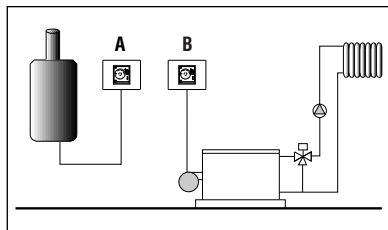
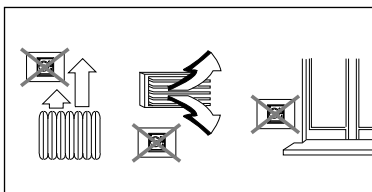
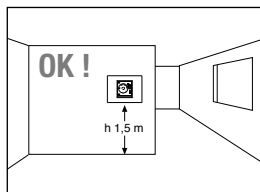

Instalaciones de calefacción con termostato que dirige:

A Caldera mural

B Quemador

C Bomba de circulación

D Electroválvula de zona

**NOTA:** Los ejemplos incluidos en la siguiente documentación son de principio

# INSTRUCCIONES PARA LA INSTALACIÓN

## Conexiones eléctricas

**Importante:** la instalación y la conexión eléctrica de los dispositivos y equipos tienen que ser llevados a cabo por personal cualificado y según las normas y leyes en vigor. El fabricante no se asume ninguna responsabilidad en lo que concierne al empleo de productos que requieran particulares normas de ambiente y/o instalación, cuya responsabilidad corre a cargo del instalador.

**Atención:** antes de efectuar la instalación del aparato, hay que desactivar la tensión de red.

Con la tensión de red desactivada:

Conectar los cables de alimentación a las bornas n° L (Línea) y n° N (Neutro).

Conectar a las bornas los cables del dispositivo a controlar:

n° 1 = contacto NA

n° 2 = común

n° 3 = contacto NC

Con fuertes cargas inductivas (bombas y electroválvulas) se aconseja conectar un filtro RC en paralelo respecto a la carga.

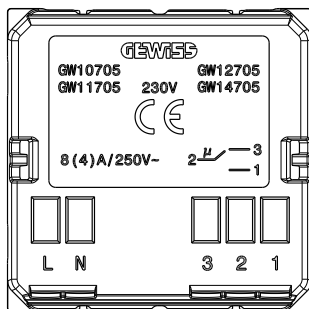

### Bornas de cableado

Alimentación: L - Fase  
N - Neutro

Relé de salida: 1 = contacto NA  
2 = común  
3 = contacto NC

# INSTRUCCIONES PARA EL EMPLEO

## Mandos y señalizaciones

Aguja indicadora  
de referencia  
para fijación temperatura

Selector para regulación  
modo de trabajo  
verano ☀ / OFF / invierno ❄

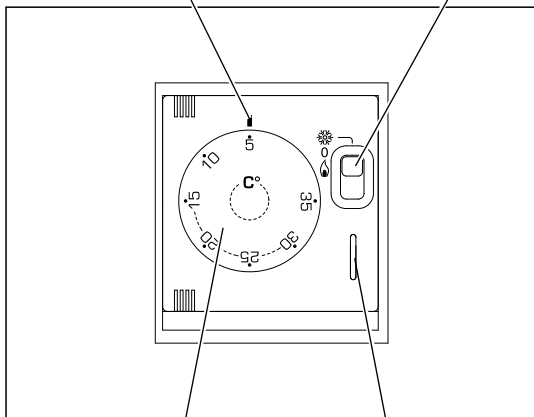

Manecilla con escala  
temperaturas: 5°C ÷ 35°C

Led señalización estado  
de la carga:  
encendido = carga activada



**D E U T S C H**

**Elektronischer Thermostat sommer/winter**

## **Achtung - Wichtig**

**Achtung !** Die Gerätesicherheit wird nur gewährleistet, wenn diese Anweisungen strikt eingehalten werden. Diese Unterlagen sorgfältig durchlesen und sicher aufbewahren.

Die Produkte der Baureihe Chorus können in staubfreier Umgebung installiert werden, in der kein spezieller Schutz gegen das Eindringen von Wasser notwendig ist.

Sie müssen in Übereinstimmung mit den Vorschriften für Haushaltsgeräte installiert werden, die durch im Installationsland geltenden Normen und Bestimmungen für Niederspannungsanlagen geregelt werden. Falls solche nicht vorgesehen sind, muss man die internationale Norm für Niederspannungsanlagen, IEC 60364, oder den Europäischen Harmonisierungsdokument HD 60364 beachten.

Für genauere Informationen und technische Daten wenden Sie sich bitte an den Vertrieb von Gewiss.

# INHALTSVERZEICHNIS

<b>ALLGEMEINE CHARAKTERISTIKEN DES PRODUKTES</b>	<i>Seite</i>
- Funktionen .....	36
<b>INSTALLATIONSANLEITUNG</b>	
- Anwendungslogik .....	37
- Elektrische Anschlüsse .....	39
<b>BETRIEBSANLEITUNG</b>	
- Bedienelemente und Anzeigen.....	40

## Funktionen

### LEISTUNGSDATEN

---

Funktion Sommer / Winter.

Leuchtanzeigen:

- Gelbe LED Funktion Lokalisierung.
- Grüne LED Anzeige Zustand Ausgang (eingeschaltet Kontakt NO geschlossen).

### TECHNISCHE KENNDATEN

---

Versorgungsspannung:	230 V~ 50÷60 Hz
Aufgenommene Leistung:	2VA
Ausgang über Relais mit Anschluss:	Schließer/Umschalter/Öffner 8(2)A / 250 V~
Geräteanschlüsse (Last):	2 oder 3 Leiter
Max. Querschnitt der Leiter an den Klemmen:	2,5 mm <sup>2</sup>
Isolierung:	Klasse II 
Schutzgrad:	IP 30
Verschmutzung:	Normal
Regelbereich:	von +5°C bis +35°C
Hysterese:	1°C
Betriebstemperaturgrenzwerte:	0°C ÷ +50°C
Bezugsnormen für CE-Zeichen:	
EMC EN55014-1 EN55014-2 EN61000-3-2 EN61000-3-3	
LVD EN60730-1 EN60730-2-9	
(EWG-Richtlinien 2006/95/EG - 2004/108/EG)	

## Anwendungslogik

OK

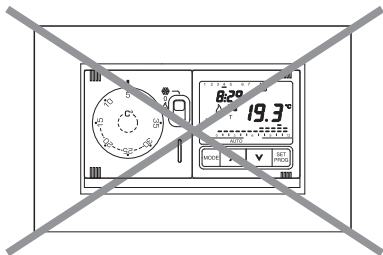
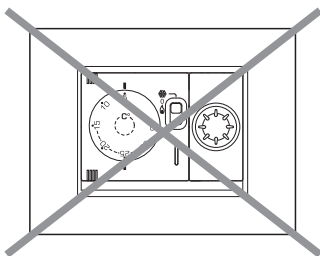
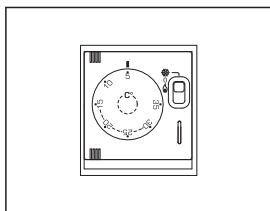

## Anwendungslogik

### Hinweise zur Anbringung:

Der Thermostat in einer Höhe von  $1,50 \div 1,70$  m über dem Boden in sicherem Abstand von Wärmequellen, Luftzug oder Fenstern installieren. Die Installation an Außenmauern ist verboten.

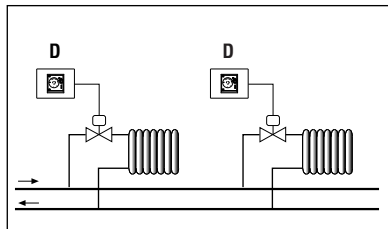
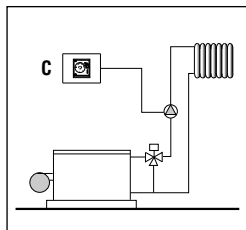
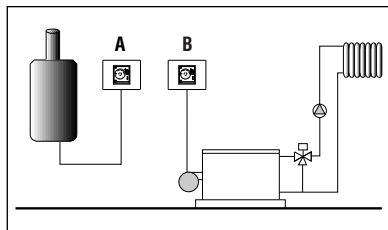
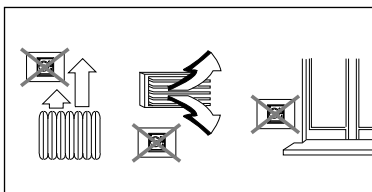
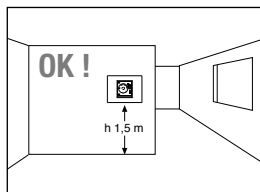

Heizungsanlagen mit Thermostat zur Steuerung von:

- A** Wandbefestigten Heizkesseln
- B** Brennern
- C** Umwälzpumpen
- D** Bereichsventilen

**N.B.:** Die in der folgenden Dokumentation dargestellten Beispiele dienen nur zur Orientierung.

## Elektrische anschlüsse

**Wichtig:** Installation und elektrischer Anschluss der Vorrichtungen und Geräte müssen von qualifiziertem Fachpersonal nach den geltenden Vorschriften und Gesetzen ausgeführt werden. Der Hersteller übernimmt keinerlei Haftung für die Verwendung von Produkten, die speziellen Umwelt- und/oder Installationsvorschriften unterliegen; dies liegt im Verantwortungsbereich des Installateurs und geht zu dessen Lasten.

**Achtung:** Vor der Installation des Geräts Netzspannung abschalten.

Bei abgeschalteter Netzspannung:

Die Adern der Versorgung an die Klemmen L (Phase) und N (Nullleiter) anschließen.

Die Adern des zu steuernden Geräts an folgende Klemmen anschließen:

Nr 1 = Kontakt NO

Nr 2 = Allgemein

Nr 3 = Kontakt NG

Bei hohen induktiven Lasten (Pumpen und Magnetventile) sollte ein RC-Filter parallel zur Last angeschlossen werden.

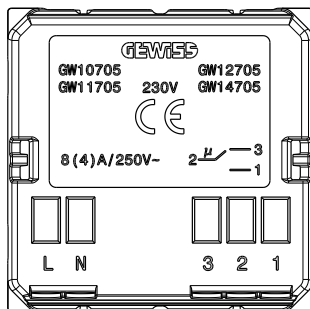

### Verkabelungsklemmen

Stromversorgung : L - Phase  
N - Nullleiter

Ausgangsrelais: 1 = Kontakt NO  
2 = Allgemein  
3 = Kontakt NG

## ► Bedienelemente und anzeigen

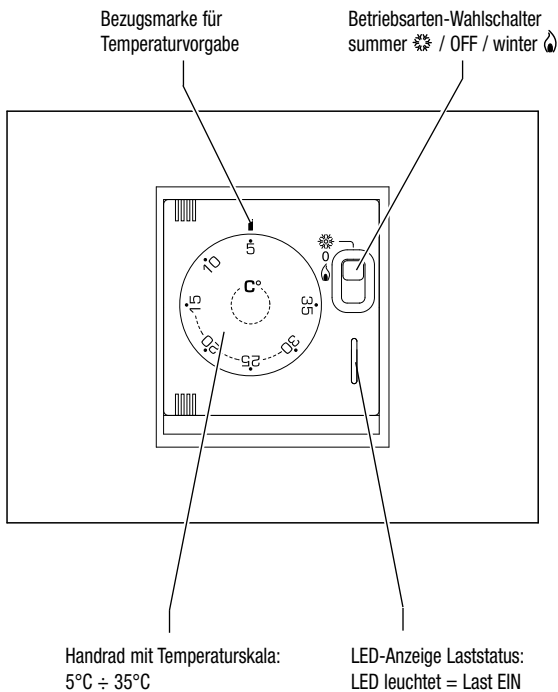



**R O M Â N Ă**

**Termostat electronic vară/iarnă**

## ► **Atenție - Important**

**Atenție!** Siguranța aparatului este garantată doar prin respectarea riguroasă a instrucțiunilor din prezentul manual. Prin urmare, citiți-le și asigurați-vă că le aveți întotdeauna la îndemână.

Produsele Chorus trebuie să fie instalate conform dispozițiilor normei CEI 64-8 privind aparatele de uz casnic și similare, în medii fără praf și în care nu este necesară o protecție specială împotriva pătrunderii apei.

Punctele de vânzare GEWISS vă stau la dispoziție pentru clarificări și informații tehnice.

<b>DATE GENERALE PRODUS</b>	<i>pag.</i>
- Funcții .....	44
<b>INSTRUCȚIUNI DE INSTALARE</b>	
- Logica aplicativă .....	45
- Conexiuni electrice .....	47
<b>INSTRUCȚIUNI DE UTILIZARE</b>	
- Comenzi și semnalizări.....	48

## Funcții

### DATE PRIVIND PERFORMANȚELE

---

Funcție vară / iarnă.

Semnale luminoase:

- LED galben funcție de localizare.

- LED verde de indicare a stării ieșirii (acces contact ND închis).

### DATE TEHNICE

---

Tensiune de alimentare :	230 V~ 50+60 Hz
Puterea absorbită:	2VA
Contact de ieșire :	cu releu cu contact de schimb ND/COM/NÎ 8 A / 250 V~
Conexiuni utilizator (sarcină) :	2 sau 3 conductoare
Secțiunea maximă a firelor către terminale:	2,5 mm <sup>2</sup>
Tip izolație:	Clasa II 
Grad de protecție:	IP 30
Nivel de poluare:	Normal
Plajă de reglare :	de la +5°C la +35°C
Diferențial termic:	1°C
Limite temperatură funcționare :	0°C + +50°C
Standarde de referință pentru marcajul CE:	
EMC EN55014-1 EN55014-2 EN61000-3-2 EN61000-3-3	
LVD EN60730-1 EN60730-2-9	
(Directivile 2006/95/CE - 2004/108/CE)	

## Logica aplicativă

OK

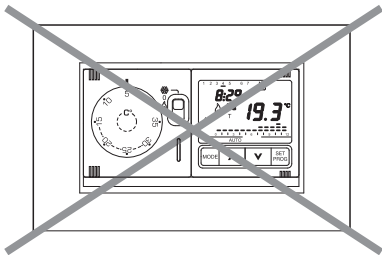
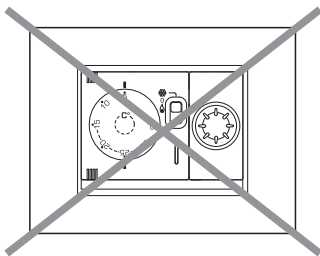
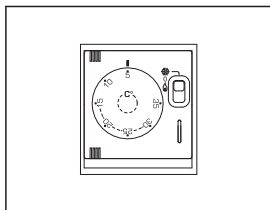

# INSTRUCȚIUNI DE INSTALARE

## Logica aplicativă

### Sfaturi cu privire la amplasare:

Instalați termostatul la o înălțime de 1,50+1,70 m față de pardoseală, departe de surse de căldură, prize de aer, uși sau ferestre. Este interzisă instalarea pe pereți perimetrali.

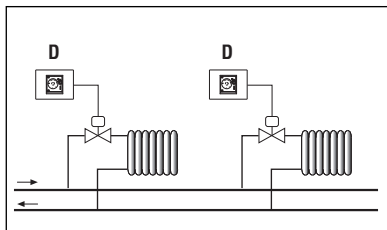
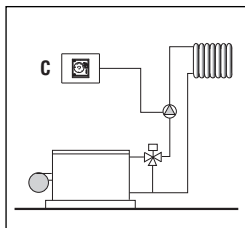
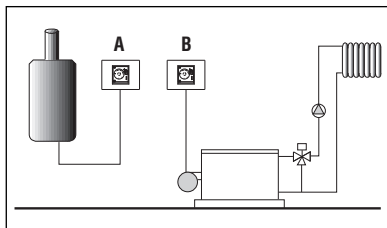
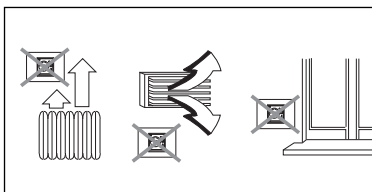
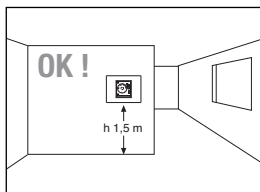

Sisteme de încălzire cu termostată de comandă pentru:

- A Centrală de perete
- B Arzător
- C Pompă de circulație
- D Electrovalvă de zonă

N.B.: Exemplele din documentul de mai jos sunt cu titlu ilustrativ

## Conexiuni electrice

**Important:** Instalarea și conexiunea electrică a dispozitivelor și aparatelor trebuie să fie efectuate de personal calificat și în conformitate cu normele și legile în vigoare. Producătorul nu își asumă nicio responsabilitate în ceea ce privește utilizarea produselor care trebuie să respecte anumite standarde de mediu și/sau de instalare, aceste obligații fiind în sarcina instalatorului.

**Atenție:** Înainte de a instala produsul, întrerupeți alimentarea cu energie electrică de la rețea.

După întreruperea alimentării:

Conectați firele de alimentare la terminalele L (Fază) și N (Nul).

Conectați firele dispozitivului care doriți să fie controlat la terminalele:

1 = contact ND

2 = comun

3 = contact NÎ

Cu sarcini inductive mari (pompe și electrovalve) se recomandă legarea unui filtru RC în paralel cu sarcina.

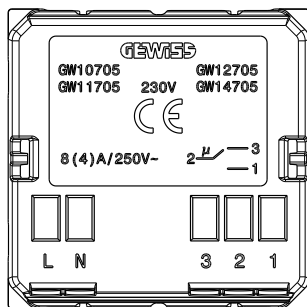

### Terminale de cablare

Alimentare : L - Fază  
N - Nul

Relev de ieșire: 1 - Contact ND  
2 - Contact comun  
3 - Contact NÎ

# INSTRUCȚIUNI DE UTILIZARE

## Comenzi și semnalizări

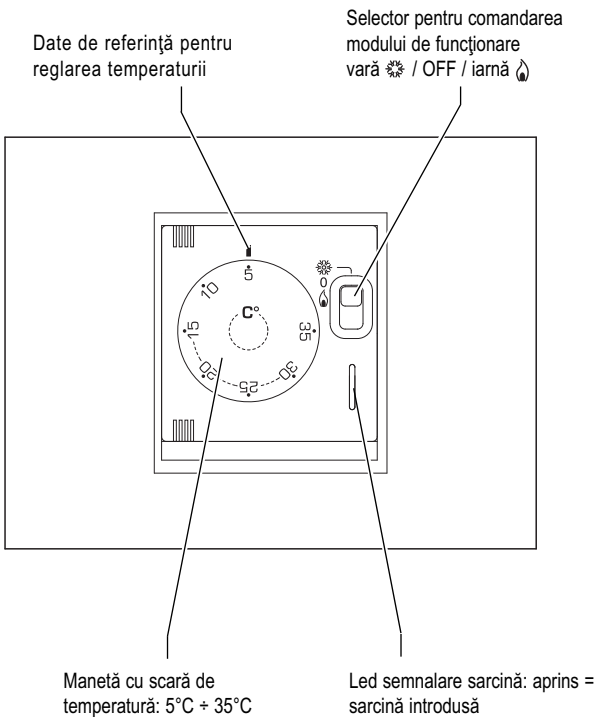









Ai sensi delle Decisioni e delle Direttive Europee applicabili, si informa che il responsabile dell'immissione del prodotto sul mercato Comunitario è:  
*According to the applicable Decisions and European Directives, the responsible for placing the apparatus on the Community market is:*

**GEWISS S.p.A. Via A.Volta, 1 IT-24069 Cenate Sotto (BG) Italy Tel: +39 035 946 111 Fax: +39 035 946 270 E-mail: [qualitymarks@gewiss.com](mailto:qualitymarks@gewiss.com)**

SAT

**+39 035 946 111**8.30 - 12.30 / 14.00 - 18.00  
lunedì + venerdì - monday + friday**+39 035 946 260****sat@gewiss.com**  
**[www.gewiss.com](http://www.gewiss.com)**